

AUSTRALIAN VETERINARY EMERGENCY PLAN

AUSVETPLAN

Operational Manual

Disposal

Version 3.1, 2015

AUSVETPLAN is a series of technical response plans that describe the proposed Australian approach to an emergency animal disease incident. The documents provide guidance based on sound analysis, linking policy, strategies, implementation, coordination and emergency-management plans.

National Biosecurity Committee

This manual forms part of:

AUSVETPLAN Edition 3

This manual will be reviewed regularly. Suggestions and recommendations for amendments should be forwarded to:

AUSVETPLAN — Animal Health Australia
Executive Manager, Emergency Preparedness and Response
Suite 15, 26–28 Napier Close
Deakin ACT 2600
Tel: 02 6232 5522; Fax: 02 6232 5511
email: admin@animalhealthaustralia.com.au

Approved citation: Animal Health Australia (2015). Operational manual: Disposal (Version 3.1). Australian Veterinary Emergency Plan (AUSVETPLAN), Edition 3, National Biosecurity Committee, Canberra, ACT.

Publication record:

Edition 1: 1992

Edition 2: 1996

Edition 3:

Version 3.0: 2007 (major update and inclusion of new cost-sharing arrangements)

Version 3.1: 2015 (major update)

AUSVETPLAN is available on the internet at:

www.animalhealthaustralia.com.au

© Commonwealth of Australia and each of its states and territories, 2015

ISBN 0 642 24506 1 (printed version)

ISBN 1 876 71438 7 (electronic version)

This work is copyright and, apart from any use as permitted under the *Copyright Act 1968*, no part may be reproduced without written permission from the publishers, the Australian Government Department of Agriculture and Animal Health Australia, acting on behalf of the National Biosecurity Committee. Requests and inquiries concerning reproduction and rights should be addressed to AUSVETPLAN — Animal Health Australia (see above).

The publishers give no warranty that the information contained in AUSVETPLAN is correct or complete, and shall not be liable for any loss howsoever caused, whether due to negligence or other circumstances, arising from use of or reliance on this code.

DISEASE WATCH HOTLINE

1800 675 888

The Disease Watch Hotline is a toll-free telephone number that connects callers to the relevant state or territory officer to report concerns about any potential emergency disease situation. Anyone suspecting an emergency disease outbreak should use this number to get immediate advice and assistance.

Preface

This operational manual for disposal methods is an integral part of the **Australian Veterinary Emergency Plan**, or **AUSVETPLAN (Edition 3)**. AUSVETPLAN structures and functions are described in the AUSVETPLAN **Summary Document**.

This manual has been produced in accordance with the procedures described in the AUSVETPLAN **Summary Document** and in consultation with Australian national, state and territory governments, and the relevant industries.

In this manual, text placed in square brackets [xxx] indicates that that aspect of the manual remains contentious or is under development; such text is not part of the official manual. The issues will be worked on by experts and relevant text included at a future date.

Guidelines for the field implementation of AUSVETPLAN are contained in the disease strategies, operational manuals, management manuals and wild animal response strategy. Industry-specific information is given in the relevant enterprise manuals. The full list of AUSVETPLAN manuals that may need to be accessed in an emergency is shown below. The complete series of manuals is available on the Animal Health Australia website.¹

AUSVETPLAN manuals

Disease strategies

- Individual strategies for each of 35 diseases
- Bee diseases and pests
- Response policy briefs (for diseases not covered by individual manuals)

Operational manuals

- Decontamination
- Destruction of animals
- Disposal
- Livestock welfare and management
- Valuation and compensation
- Wild animal response

Enterprise manuals

- Artificial breeding centres
- Feedlots
- Meat processing
- Pig industry
- Poultry industry
- Saleyards and transport
- Zoos

Management manuals

- Control centres management (Parts 1 and 2)
- Laboratory preparedness

Summary document

Nationally agreed standard operating procedures²

Nationally agreed standard operating procedures (NASOPs) have been developed for use by jurisdictions during responses to emergency animal disease incidents and emergencies. These procedures underpin elements of AUSVETPLAN and describe in detail specific actions undertaken during a response to an incident.

¹ www.animalhealthaustralia.com.au/programs/emergency-animal-disease-preparedness/ausvetplan/

² www.animalhealthaustralia.com.au/programs/emergency-animal-disease-preparedness/nasops/

The following NASOPs are of relevance:

- 01 Personal decontamination – entry and exit procedures
- 03 Loading and unloading of carcasses and materials for biosecure transport
- 12 Decontamination of large equipment
- 26 Decontamination of groups of people – entry and exit procedures
- 27 Biosecure movement of contaminated carcasses and materials – during road transport.

In addition, each jurisdiction will have its own standard operating procedures, which should be followed.

Contents

Preface.....	3
1 Introduction.....	10
1.1 Purpose of this manual	10
1.2 Predisposal issues.....	10
2 The decision-making framework.....	12
2.1 Introduction.....	12
2.2 Planning before responses.....	12
2.3 Decision-making process.....	13
2.4 Establishment of an expert team	14
2.5 Waste material type and quantity	15
2.6 Classification of material	15
2.7 Predisposal processing.....	16
2.8 Decision making and recommendation.....	16
2.9 Media and community engagement	17
3 Factors to be considered.....	18
3.1 Introduction.....	18
3.2 The disease.....	20
3.3 Transport.....	20
3.4 Environment.....	22
3.5 Safety	22
3.6 Legislative requirements and regulatory approval	23
3.7 Community concerns	23
3.8 Cost.....	24
3.9 Timeliness	24
3.10 Industry standards and agreements	24
3.11 International community.....	24
3.12 Resources	25

4	Methods of disposal	26
4.1	Introduction.....	26
4.2	Burial	28
4.2.1	Process overview.....	28
4.2.2	Disease agent considerations.....	29
4.2.3	Volume of material for disposal.....	29
4.2.4	Location.....	29
4.2.5	Environmental implications	30
4.2.6	Remediation requirements (including monitoring).....	31
4.2.7	Time considerations.....	32
4.2.8	Cost considerations.....	32
4.2.9	Resource requirements.....	33
4.2.10	Health and safety	34
4.2.12	Advantages and disadvantages of burial	35
4.3	Burning.....	37
4.3.1	Process overview.....	37
4.3.2	Disease agent considerations.....	39
4.3.3	Volume of material for disposal.....	39
4.3.4	Location.....	39
4.3.5	Environmental implications	40
4.3.6	Monitoring and remediation	41
4.3.7	Time considerations.....	41
4.3.8	Cost considerations.....	41
4.3.9	Resource requirements.....	42
4.3.10	Health and safety considerations.....	42
4.3.11	Advantages and disadvantages of burning	44
4.4	Rendering.....	46
4.4.1	Process overview.....	46
4.4.2	Disease agent considerations.....	46
4.4.3	Volume of material for disposal.....	46
4.4.4	Location.....	46
4.4.5	Environmental implications	46
4.4.6	Monitoring and remediation requirements.....	46
4.4.7	Time considerations.....	46
4.4.8	Cost considerations.....	47
4.4.9	Resource requirements.....	47
4.4.10	Health and safety considerations.....	47
4.4.11	Advantages and disadvantages of rendering	48
4.5	Composting	49
4.5.1	Process overview.....	49
4.5.2	Disease agent considerations.....	50
4.5.3	Volume of material for disposal.....	50
4.5.4	Location.....	50
4.5.5	Environmental implications	50
4.5.6	Monitoring and remediation requirements.....	51
4.5.7	Time considerations.....	51
4.5.8	Cost	51
4.5.9	Resource requirements.....	51
4.5.10	Health and safety considerations.....	52

4.5.11	Advantages and disadvantages of composting.....	53
4.6	Anaerobic digestion	54
4.6.1	Process overview.....	54
4.6.2	Disease agent considerations.....	54
4.6.3	Volume of material for disposal.....	54
4.6.4	Location.....	54
4.6.5	Environmental implications	54
4.6.6	Monitoring and remediation requirements.....	54
4.6.7	Time considerations.....	54
4.6.8	Cost	55
4.6.9	Resource requirements.....	55
4.6.10	Health and safety considerations.....	55
4.6.11	Advantages and disadvantages of anaerobic digestion	56
4.7	Other methods of disposal	57
4.7.1	Alkaline hydrolysis.....	57
4.7.2	Leave in situ ('destroy and let lie')	57
4.7.3	Ocean disposal.....	57
4.7.4	Refeeding to nonsusceptible species	58
5	Items requiring special consideration.....	59
5.1	Milk and other dairy products.....	59
5.1.1	Feeding to animals.....	59
5.1.2	Spraying onto pastures after inactivation of pathogen.....	59
5.1.3	Composting.....	59
5.1.4	Burial.....	60
5.1.5	Commercial waste disposal (landfill or composting)	60
5.1.6	Processing into milk powder for storage and subsequent disposal	60
5.1.7	Use of central effluent wastewater disposal sites.....	60
5.1.8	Use of tallow recyclers.....	60
5.1.9	Use of effluent ponds on farm.....	60
5.2	Hatching eggs and hatchery waste	61
5.3	Effluent.....	61
5.3.1	Effluent management during an emergency animal disease response.....	61
5.3.2	Dairy processing facilities.....	61
5.3.3	Dairy farms	61
5.3.4	Piggeries	62
5.4	Manure and litter.....	62
5.5	Wool and mohair	62
5.6	Semen and ova	62
5.7	Laboratory wastes.....	63
Appendix 1	Types of potentially contaminated materials	64
Appendix 2	Predisposal processing options	70

Appendix 3	Environmental checklist	74
Appendix 4	Transport checklist	80
Appendix 5	Form for reporting recommendations to LCC Controller on disposal options	82
Appendix 6	Burial pit construction	83
Appendix 7	Pyre construction.....	87
Appendix 8	Sample decision-making process for determining appropriate disposal options	89
Appendix 9	Overview of effluent systems.....	92
Glossary		95
Abbreviations		103
References		104

Figures

Figure 2.1	Decision-making process.....	14
Figure 3.1	Summary of factors affecting disposal methods.....	19
Figure 3.2	Issues to be considered in deciding options for transport.....	21
Figure 4.1	Disposal methods.....	27
Figure 4.2	Theory of air-curtain incineration	38
Figure A6.1	Example of the dimensions of a straight-sided pit.....	84
Figure A6.2	Example of the dimensions of a battered burial pit	86
Figure A7.1	Example of construction of a pyre, including aerial view (lower diagram).....	88
Figure A9.1	Cross-section of single effluent pond, showing treatment volumes.....	94
Figure A9.2	Cross-section of double effluent pond, showing location of storage volumes in each pond	94

Tables

Table A1.1	Materials that may need to be transported and/or disposed of during an emergency animal disease response.....	64
Table A8.1	Blank decision matrix.....	90
Table A8.2	Example matrix with weightings	90
Table A8.3	Example of completed matrix	91

1 Introduction

The primary objective of disposal of carcasses, animal products, materials and wastes is to prevent the dissemination of infection. This process is therefore an essential part of an animal disease eradication program. Disposal should be completed as soon as possible after destruction to minimise opportunities for infectious material to disperse.

Although rapid disposal is of primary importance, it must be undertaken in a way that does not increase the risk of spread of the disease, or adversely affect the environment or the community. Care needs to be taken to classify all waste according to its potential infectivity. State and territory legislation relating to the classification and disposal of waste materials must be considered and, where possible, the relevant provisions followed.

As part of preparedness planning, potential stakeholders should be identified and engaged in the process of identifying potential disposal methods.

1.1 Purpose of this manual

This manual addresses the matters to be considered when disposing of waste, including animal carcasses and animal products, for disease control purposes. It provides a decision-making framework that allows decisions on disposal methods to be assessed using weighted factors such as current legislation, operator safety, community concern, international acceptance, availability of transport, industry standards, local environment, cost-effectiveness, resource availability and speed of resolution. The importance of each factor will vary with each animal health emergency. The approach allows logical, defensible and transparent decisions to be made on disposal of waste from an animal health emergency, using one method or a combination of methods.

Since each event will differ in its extent, the available resources, the risk to operators and the suitability of available disposal methods, this manual does not seek to provide solutions for every possible eventuality.

In any major animal health emergency, disposal methods used at the beginning of a campaign may be superseded by more appropriate methods as the extent of the response is better understood. The solutions are likely to be a combination of the most appropriate technologies.

This manual should not be read in isolation. Reference should also be made to the relevant **AUSVETPLAN Disease Strategy**, the **Decontamination Manual**, relevant nationally agreed standard operating procedures and jurisdictional standard operating procedures.

This manual does not include possible avenues of waste minimisation, such as slaughter of animals (uninfected or vaccinated) for human consumption, or potential treatment of animal products to render them suitable for human or animal consumption.

1.2 Predisposal issues

Carcasses and other items awaiting disposal pose a high risk of disease spread. They should be contained to prevent unauthorised access, and to prevent domestic pets, wild animals

and birds from removing potentially infectious material. People attempting to gain unauthorised access might include distressed animal owners, animal rights activists, local stakeholders, unauthorised media, disgruntled employees and the curious public. Control of insects and rodents should be considered if there is a risk of passive transmission to nearby susceptible species. If disposal is delayed, carcasses should be thoroughly sprayed with an approved disinfectant (see the **Decontamination Manual**) and covered, if possible.

All site hazards, including the exposure of personnel to potential zoonotic infection, must be identified and assessed, and appropriate controls must be implemented, before disposal work begins. Personnel should be fully trained and briefed, including on the nature of the disease and any hygiene requirements.

Overall management of disposal operations is described in the **Control Centres Management Manual**, Parts 1 and 2 (in particular, reference to infected premises management in Part 2).

2 The decision-making framework

2.1 Introduction

Disposal of animal carcasses, materials and equipment (fomites) used in the husbandry of animals, and products and byproducts created by the enterprises involved is a major concern in an emergency animal disease (EAD) response.

To assess and prioritise disposal methods according to their appropriateness, a decision-making framework should include all relevant factors, and be flexible enough to allow modifications for different situations and locations. In small-scale responses or the early stages of a response, a number of different disposal methods may be appropriate. For a large-scale response, a single method is likely to predominate.

The decision-making framework includes the selection of an expert team to review a particular field situation and follow a structured decision-making process, and make recommendations to the controller of the operation. The recommendations (see Appendix 5) will be delivered to the controller of the local control centre (LCC). This approach allows consideration of all available disposal methods and the application of the best solution at the local level, while being acceptable in the broader context of an EAD response.

2.2 Planning before responses

Prior planning should be undertaken by animal health authorities, in conjunction with all stakeholders, including environment protection agencies, local government, and other agencies and service providers (eg excavation and transport contractors, waste disposal operators). This is particularly relevant for enterprises with large numbers of livestock, such as cattle feedlots and piggeries.

Planning before responses, possibly including formal agreements, may provide the opportunity to resolve and clarify areas of concern. Environmental agencies may be able to provide guidance and contacts for the relevant licensing policy experts. A fast-track or emergency approval process might be available as the basis of agreements or standard operating procedures, to ensure timely approvals under particular circumstances.

Some legislation may provide exemptions, such as that the minister may, with the approval of the governor, declare by order that the provisions of an Act do not apply in respect of:

- a particular area of the state, or
- a specified premises, act or thing, or
- premises, acts or things in a specified class or situated in a specified area of the state.

The most efficient method of using such exemptions may be to set up a memorandum of understanding (MOU) with the appropriate environmental agency.

Approval of a previously unexplored site for disposal is the least preferred option, because it may require a complex assessment that may take some time. If this is to be considered as an option, there may need to be an MOU between the agencies with a clear and well-defined

process for a rapid approval process. This could be open to challenge as not complying with the relevant legislation.

A list of disposal sites and procedures pre-approved by the appropriate agencies may be a more practical and safe option.

2.3 Decision-making process

Overseas experience in the United Kingdom (Scudamore et al 2002), Japan (2010) and the Republic of Korea (2010) has shown that the urgency of containing an EAD often overwhelms the ability of those working on disposal to keep up. Disposal must be conducted in a way that takes into account factors such as the feelings of affected farmers and communities, the need for disposal methods to be publicly and internationally acceptable, and the need to ensure that disposal does not leave the community with a long-term or permanent adverse environmental inheritance.

Local conditions (eg position of the watertable, bushfire restrictions), available resources (eg fuel, transport), timeliness, and state or territory environment protection legislation must be considered and may limit practical disposal methods. Other factors for consideration include safety, cost, the disease, and industry standards and agreements. Section 3 outlines the factors that may affect the decision-making process.

Disposal methods cannot be considered in isolation from factors that may determine or limit the methods available at the time (Figure 3.1). Section 4 outlines the disposal methods. Figure 4.1 gives a schematic representation of disposal methods.

All wastes need to be considered concurrently. There may be potential for disposal of one waste to complement disposal of another – for example, composting of poultry carcasses and poultry litter.

Figure 2.1 outlines the sequence of steps in the decision-making process.

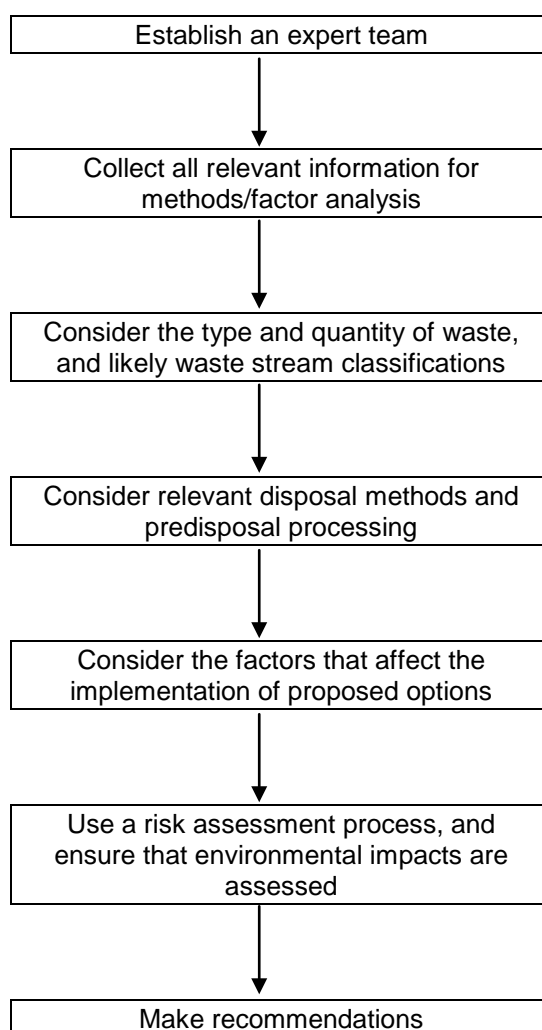

Figure 2.1 Decision-making process

2.4 Establishment of an expert team

Decisions about the classification of wastes, and transport and disposal of carcasses and other potentially infective material should never be made in isolation. The LCC Operations Management function, with assistance from LCC Planning Management, is responsible for bringing together a team of relevant experts to gather the information, complete the decision-making process and make a recommendation(s).

Membership of the expert team will vary with the incident, and the disposal methods and factors being considered. It is important to keep the focus at the local level. The team needs to be assembled quickly and provide its recommendations as soon as possible. Delays in carcass disposal can result in public health concerns, and increased stress to animal owners and local communities, and may reduce the available disposal methods (eg it is difficult to transport autolysed carcasses).

The following list provides a guide to the expertise that might be required. One member of the team may provide a number of different areas of expertise. A smaller group of representatives may be required to efficiently undertake tasks such as site inspections, and then report back to the whole team before recommendations are made:

- LCC Operations Management function (chair)
- animal health expert with knowledge of the disease and the required level of biosecurity
- environmental agency representative(s)
- civil engineer
- LCC Planning Management or delegate
- LCC Infected Premises Operations function or delegate
- industry representative(s)
- local emergency management officer(s)
- local council or community representative(s)
- transport coordinator(s)
- local health authority representative
- other agencies, as appropriate (eg water authority, lands authority, emergency services, health department, rendering plant, waste disposal, landfill site).

It is important that the membership of this team, the decision-making process followed and the recommendations made are documented, to facilitate transparency in decision making and allow decisions taken to be reviewed later.

2.5 Waste material type and quantity

Waste materials that may need to be transported or disposed of during an EAD response are listed in Appendix 1.

Different disease outbreaks will require different control measures, resulting in different types and amounts of waste. An eradication plan that requires the slaughter of all infected and at-risk animals, and the decontamination and disposal of associated materials (such as for foot-and-mouth disease) would produce large amounts of waste in a short time. An outbreak of bovine spongiform encephalitis, on the other hand, would probably require disposal of fewer carcasses and animal products over a prolonged period. Some intensive industries produce larger quantities of waste products than others.

Many Australian waste management facilities (eg renderers, landfills, knackeries, facilities for disposal of liquid waste and hazardous materials) process wastes similar to those that might be generated during an EAD outbreak. These facilities might be able to be used for diseases that do not generate large quantities of materials for immediate disposal. Conversely, in a large outbreak, routine waste disposal techniques might not be able to cope. This applies particularly to the disposal of liquid wastes such as milk. Whereas small volumes of milk can normally be treated using ultra-high temperature, large volumes may be difficult to process.

2.6 Classification of material

Classification of the waste is important, as it will help determine the method(s) of disposal that are approved. The expert team, in consultation with relevant authorities, will classify the wastes that may arise from the EAD response.

The waste materials that can result from an EAD outbreak are many and varied. Waste could fall under class 6.2 (infectious substances) of the Australian Dangerous Goods Code, but the classification of waste may vary between state and territory jurisdictions. Although it may be possible to bypass waste disposal legislation if a state of emergency is enacted, it would be preferable to meet the requirements of the relevant environmental legislation to avoid short-term and long-term environmental damage.

2.7 Predisposal processing

Predisposal processing of carcasses, animal parts, products and fomites in an EAD response may increase options for their transport and disposal, and could be crucial in determining the most appropriate and cost-effective disposal methods. If the infectivity of a material can be reduced or eliminated, less restrictive methods of handling and transport may be possible. It might also be possible to modify the form of the material to make it easier to handle, make alternative transport methods viable, and possibly speed up the disposal and decomposition process.

Appendix 2 gives some predisposal processing methods, and their advantages and disadvantages.

Care must be taken to ensure that predisposal processing does not increase the risk of spreading the disease, result in excessive additional costs, or add to work health and safety concerns.

2.8 Decision making and recommendation

The expert team, using a structured decision-making process, such as the appreciation process or another documented method used in the affected jurisdiction, will consider the relevant factors (see Section 3) and their impact on the relevant disposal methods (see Section 4), to determine a ranked list of suitable disposal methods.

A two-dimensional matrix (see Appendix 8) aims to give structure to the consideration of complex interactions in a way that demonstrates the transparency of the expert team's decision. The matrix, or another documented method for reaching a decision, allows a variety of different disposal methods to be considered for the existing conditions. This technique uses the weighting of various factors and an assessment of their utility to reach a conclusion on the most suitable of the available disposal methods. If a disposal method is not available for operational or disease management reasons, it is excluded from the process at the outset. Members of the team work on the matrix together, and the result should be a ranked list of acceptable disposal methods agreed by the majority of the team. This process should be guided by a skilled facilitator, who may be part of the LCC Operations Management function. The ranked list needs to be determined within a short timeframe.

It will probably be necessary to perform this process for different types of wastes that have different handling and disease risk characteristics. A 'one size fits all' solution is unlikely.

As with all decisions made in an EAD response, the process by which the recommendation on disposal is decided must be transparent and accountable. To achieve this, a standard format should be followed for submitting the recommendation to the LCC. The recommendation must include a list of the members of the team who completed the process, the ranked list of recommended disposal methods, a list of reference materials referred to,

and a brief summary of the advantages and disadvantages of each option. A suggested report format can be found in Appendix 5.

2.9 Media and community engagement

This section should be read in conjunction with the *Biosecurity incident public information manual*,³ with specific reference to:

- the role of the Biosecurity Incident National Communications Network
- the public information function during an EAD response.

It is important to clearly state to the public and media that:

- the disposal methods being used were adopted on the recommendations of an expert panel
- disposal arrangements must not impede disease control measures, particularly slaughter of infected animals; delays in disposal will potentially result in spread of the disease – this will necessitate the slaughter of more animals and/or reduce the disposal methods available, because disposal of decomposing carcasses is difficult.

Communications plans should address the concerns of the community (see Section 3.7 for further details).

³ www.animalhealthaustralia.com.au/programs/emergency-animal-disease-preparedness/ausvetplan/resource-documents

3 Factors to be considered

3.1 Introduction

A variety of factors will affect the decision-making process and the disposal method(s) recommended (see Figure 3.1). The relative importance of each factor will depend on the local situation. The epidemiology of the disease may mean that some disposal methods are not appropriate.

Most importantly, the disposal methods chosen must prevent the dissemination of infection. They must also gain international acceptance from a disease control perspective; be generally acceptable to the local and broader community; meet legislative requirements and industry standards; and take into account community and operator safety, the local environment and transport availability. Cost-effectiveness and speed of implementation are also fundamental to the choice of disposal method.

Long-term factors, such as the maintenance, monitoring and eventual rehabilitation of disposal sites, must be considered. Emergency animal disease (EAD) outbreaks may necessitate the creation of large mono-fill waste disposal facilities that are far harder to manage in the medium and long term than mixed general wastes in terms of odour, gas and leachate generation. The statutory requirements of local, state/territory and national authorities must be met. The industry involved and those associated with it need to be reassured that the disposal process is secure. The public needs to know that food, drinking water and the environment remain safe from contamination.

Timely availability of resources, such as information, materials, expertise and equipment, must also be considered.

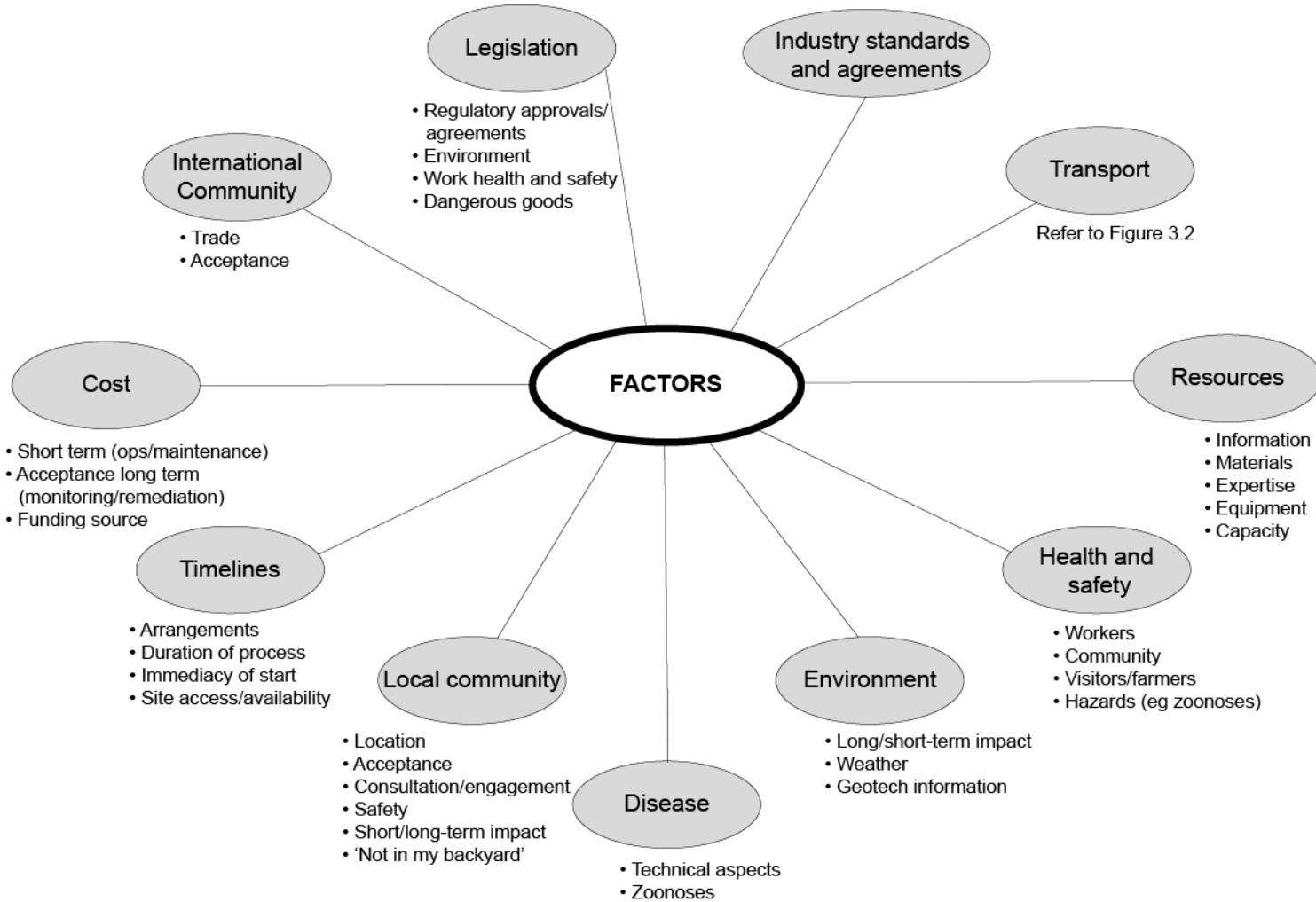

Figure 3.1 Summary of factors affecting disposal methods

3.2 The disease

The epidemiology of the EAD agent will affect the choice of transport and disposal methods. To maintain biosecurity, it is essential to understand the mechanisms involved in the transmission of the infective agent. The ability of an agent to survive a particular disposal method will determine whether that method can be used. The AUSVETPLAN resource document *Persistence of disease agents in carcasses and animal products* (Williams 2003) should be consulted.⁴ For the epidemiological characteristics of the EAD, refer to the relevant **Disease Strategy**.

3.3 Transport

See Appendix 1 for a list of materials that may need to be transported in an EAD response.

An integral part of the decision-making process is assessment of the risks of transporting carcasses or other material to the disposal sites, either within the infected premises or to another location. The infectiveness of the disease agent and the need to maintain biosecurity will determine the type of transportation required.

Waste management and other transport contractors may have vehicles suitable for the transport of carcasses and contaminated material under acceptable risk management procedures. Some specialised waste contractors are licensed to handle such wastes, and are familiar with the work health and safety (WHS) concerns – for instance, those already contracted to Quarantine Approved Premises. Selection and monitoring of transport operations should ensure that movement of materials provides the appropriate level of risk management.

If transportation is needed during an EAD response, the methods and infrastructure used will depend on interrelated factors such as the infectiveness of the disease agent, the urgency of the operation, and the cleaning and disinfection procedures required. Figure 3.2 shows the transport factors schematically. Appendix 4 lists some of the questions that arise when transport of infectious material is considered.

In a large-scale outbreak, burial, composting or other means of disposal of large numbers of carcasses at a selected site will often require specialised transport by large-capacity transport vehicles that can ensure biosecure loading. The functioning of these vehicles can be a critical element of the biosecurity of these methods of disposal. Assessing the availability of vehicles of the required type will help to determine if a disposal method is viable.

Preparedness planning should identify potential disposal sites and potential transport contractors. If material is to be transported, it is important that a comprehensive risk assessment has been completed; a biosecurity plan is in place; and appropriate local authorities have been advised of what is proposed, the routes to be taken and the safeguards that are in place before transport commences.

⁴ www.animalhealthaustralia.com.au/programs/emergency-animal-disease-preparedness/ausvetplan/resource-documents

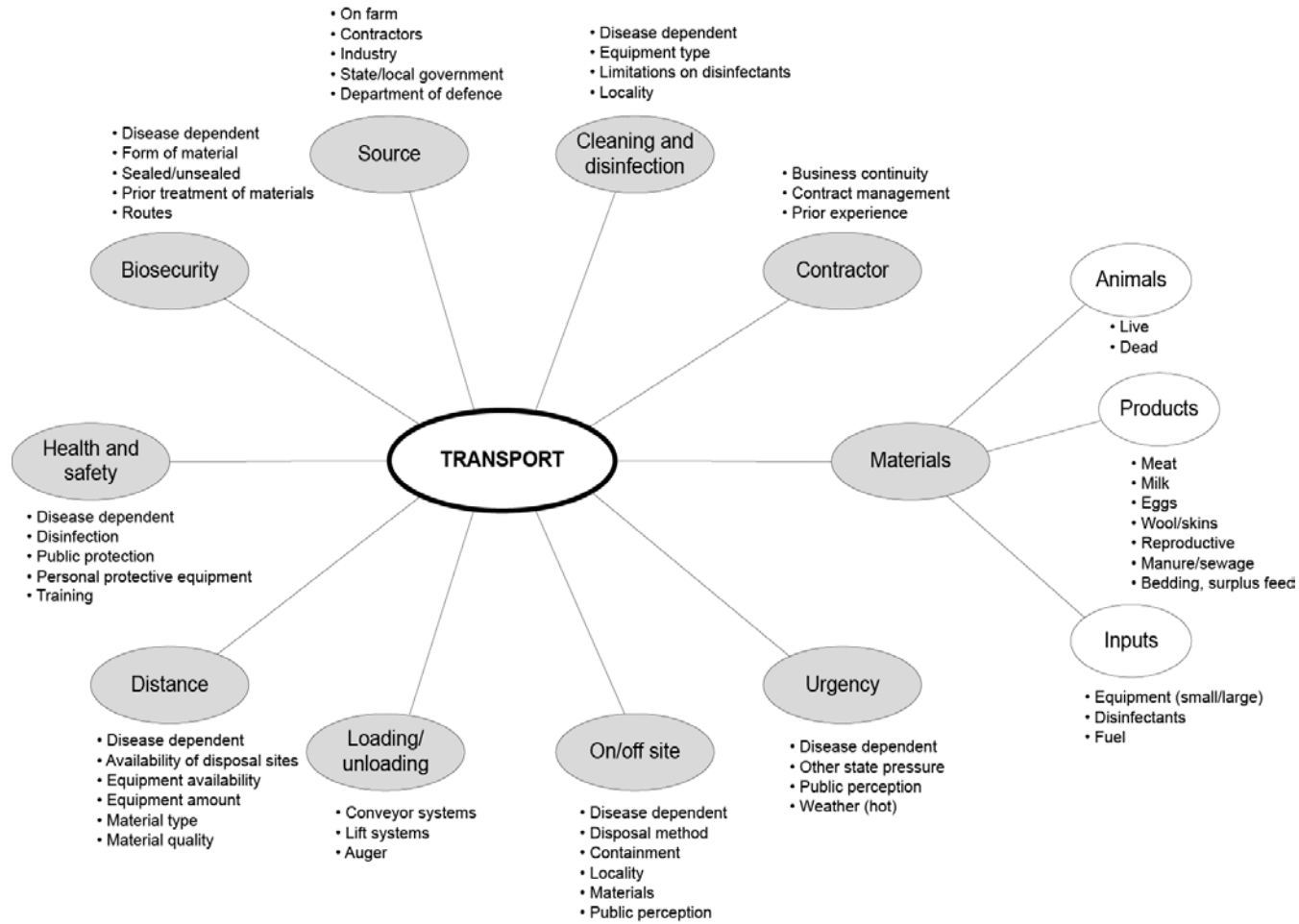

Figure 3.2 Issues to be considered in deciding options for transport

3.4 Environment

Rapid approval of disposal methods and sites for disposal may require pre-approval mechanisms involving agreements with environment protection and other agencies. Agencies responsible for EAD legislation should discuss the range of preferred and possible disposal methods, and the approval processes required for each.

Formal legal advice is required to determine whether state and territory environmental legislation or legislation relating to EAD control takes precedence in each jurisdiction. Cultural aspects, such as sacred sites, also need to be considered.

Environment protection agencies are the normal regulatory agencies for setting standards, risk assessment, design approval, licensing and monitoring for putrescible waste landfill facilities. Their input is essential in planning before responses and as early as is possible in a response, to provide sufficient lead time for key considerations for each site to be determined, and for the adequacy of design and mitigation measures to be assessed.

Environment protection agencies may not have considered in detail the types of situation that might arise during EAD outbreaks. Therefore, it is important to work with these agencies, taking into account current legislation, to evaluate the logistics required to gain approvals for a range of disposal methods within timeframes consistent with AUSVETPLAN objectives. It is important that the environment protection agencies are actively involved in all planning and training exercises involving disposal. They are essential liaison officers in the expert team in the local control centre and state coordination centre.

Appendix 3 provides an extensive list of environmental factors that may need to be taken into account. Consideration of the factors that are critical in selecting a site for possible disposal should inform agreements with environment protection agencies, so that disposal activities are not delayed. Consultation with personnel with responsibility for administration of environmental legislation, and inclusion of personnel with experience in site selection (including people with local knowledge) on the expert team will speed the decision-making process in this critical area.

Post-disposal monitoring and remediation should also be discussed with environment protection agencies, to determine appropriate responsibilities. Long-term risk management and monitoring costs are likely to be future considerations.

Locations of disposal sites must be comprehensively documented. This includes use of a GIS (geographic information system) mapping tool for potential carcass disposal sites.

3.5 Safety

Worker safety must rank highly when a disposal method is being chosen, and every effort must be made to effectively manage identified risks.

Disposal and transport require the use of large machinery, and deployment of personnel in unfamiliar surroundings. Under legislation in all states and territories, all transport and disposal activities to be carried out in the event of an EAD outbreak must be subject to risk assessments before they are undertaken, to ensure the safety of the workers involved.

A preliminary detailed risk assessment of each potential disposal method and work site should be undertaken, with appropriate input from WHS professionals. Appropriate treatment methods should be devised to minimise risks to personnel.

Some animal diseases are zoonoses; particular care must be taken to avoid transmission of such diseases to those involved in disposal operations. This might include use of personal protective equipment, vaccination of personnel, or ensuring that personnel have access to prophylactic therapy.

The safety of the community also needs to be considered at all times.

3.6 Legislative requirements and regulatory approval

Legislation varies between states or territories, and may also vary according to the location of the outbreak.

Environmental legislation, in particular, needs to be considered. However, other legislation could also affect the choice of disposal method, such as legislation that deals with the handling of dangerous goods, or WHS.

Disposal sites may trigger the need for works approval or licensing under environmental legislation. The relative precedence of environmental and EAD legislation should be determined for the jurisdiction in question. Jurisdictional legislation also needs to be examined in terms of its applicability to the proposed disposal methods – for example, ‘composting’ under the legislation might refer to the production of commercial compost, rather than disposal of waste.

Another issue to consider is that the disposal sites may become ‘contaminated sites’ under environmental or other legislation, so that they require formal reporting, investigation and management to minimise environmental and health risks. This can be a complex and expensive process, involving long-term groundwater monitoring and possible intervention.

It may be necessary to amend the restricted area to include the disposal site.

3.7 Community concerns

Potential local community concerns about the disposal method and site will need to be assessed. Ensuring that the local, as well as overall, environmental impacts of a disposal method are minimised should help to reduce community concerns. Proximity of the operation to human habitation and failure to keep the community fully informed may increase concerns. Effective consultation and ongoing liaison with the community are an important part of the decision-making process.

Transport of carcasses and contaminated materials may cause concern for the community because of the potential for spread of infection. The safeguards taken need to be clearly stated. Another specific concern is the potential for the EAD agent to spread by thermal air currents when materials are burnt. Studies in the United Kingdom in 2001 showed this to be unlikely for foot-and-mouth disease (Bourne 2001, Gloster et al 2001).

Issues that may affect the community include:

- potential generation of odours from carcasses

- the potential for leachate to pollute water supplies
- the potential for air pollution to result from burning of carcasses and other material, and the resulting impacts on health (especially for asthma sufferers)
- the extent and length of proposed monitoring programs
- use of local resources to the detriment of the local community – for example, use of local fuels; filling of local landfills; and deterioration of facilities, such as roads, due to use of heavy machinery
- potential restriction of access to facilities, such as landfill sites
- future plans for the rehabilitation of disposal sites, the time required for rehabilitation and any potential restrictions on the use of the sites.

3.8 Cost

It is difficult to fully cost the available disposal methods. In the planning process, consideration should be given to developing costing models that cover all operational costs and future monitoring costs. These models could significantly hasten the estimation of the relative costs of different disposal methods.

Consideration needs to be given to continuing costs of disposal methods that may provide quick solutions but require long-term maintenance, management and monitoring, or extensive remediation work. For example, burial may be quick, but the need for monitoring and potential problems with aquifer contamination may make it less acceptable than composting, which may need longer management but produce a desirable, readily disposable product.

3.9 Timeliness

Usually, a disposal method that neutralises the infective material as soon as possible is preferable. Some disposal methods may provide quick solutions but require long-term maintenance, management and monitoring, or extensive remediation work. These aspects need to be considered.

3.10 Industry standards and agreements

Standards vary from industry to industry and sometimes from state to state, and may vary according to the location of the outbreak. They should be considered on a local basis.

3.11 International community

Overseas trading partners will decide how soon to resume trade with Australia after an EAD outbreak. To a large extent, its confidence will be determined by Australia's appropriate use of internationally accepted methods of control and eradication, including the disposal methods used.

3.12 Resources

The availability of suitable and sufficient resources must be considered when assessing disposal methods. Resources include information, such as weather information and maps; personnel capacity and capability; equipment, including machinery (on-site, contracted, transport) and safety equipment; and materials, such as fuel sources and appropriate disinfectant.

Resource limits may affect the choice and extent of use of a particular disposal method, and the ability to comply with legislation or biosecurity requirements. Use of some resources, especially if supplies are exhausted, may have a detrimental impact on the environment and the local community.

Personnel engaged in disposal must be competent to perform their functions, which will vary for each disposal method. They may include personnel providing technical advice and support, contractors (for machinery, transport and facilities), site supervisors, safety personnel and field personnel. Given that trained personnel are likely to be a limiting resource in a large outbreak, optimum use should be made of contractors, where possible. All personnel, including contractors, must be provided with appropriate training in biosecurity and safe working practices.

Preparedness planning should identify the types of resources required, potential suppliers and limitations.

4 Methods of disposal

4.1 Introduction

In an emergency animal disease (EAD) response, there are a number of methods for disposing of carcasses and other items. The most common disposal methods for carcasses and other materials are burial (either at an existing licensed landfill site or in a specially designed and excavated pit), cremation (either on a pyre, or in an incinerator or pit burner), rendering, composting and disposal by alkaline hydrolysis (see Figure 4.1). Other disposal methods may be considered if relevant factors and risks are assessed in accordance with the transparent and systematic decision-making process outlined in this manual.

The most appropriate disposal method, or combination of methods, should result from following the decision-making process outlined in Section 2. Before work commences, it is important that appropriate advice is sought on all the factors identified in Section 3 as having a potential impact on disposal methods.

The methods used to dispose of animals, animal products and associated wastes during an EAD outbreak must be science based.

Much time can be saved by prior consultation with appropriate authorities, such as environment protection agencies, to locate appropriate potential sites and to determine the basic minimum requirements for the various options available. The 2013 National Capacity Profile for Carcass Disposal project, overseen by the National Biosecurity Committee, showed that all jurisdictions are actively engaged at a whole-of-government level in disposal preparedness.

A number of predisposal processing treatments may need to be considered before the disposal method is used. These include freezing and storage, grinding, sterilisation (using disinfectants, heat, barriers), and carcass breakdown (see Appendix 2 for more information).

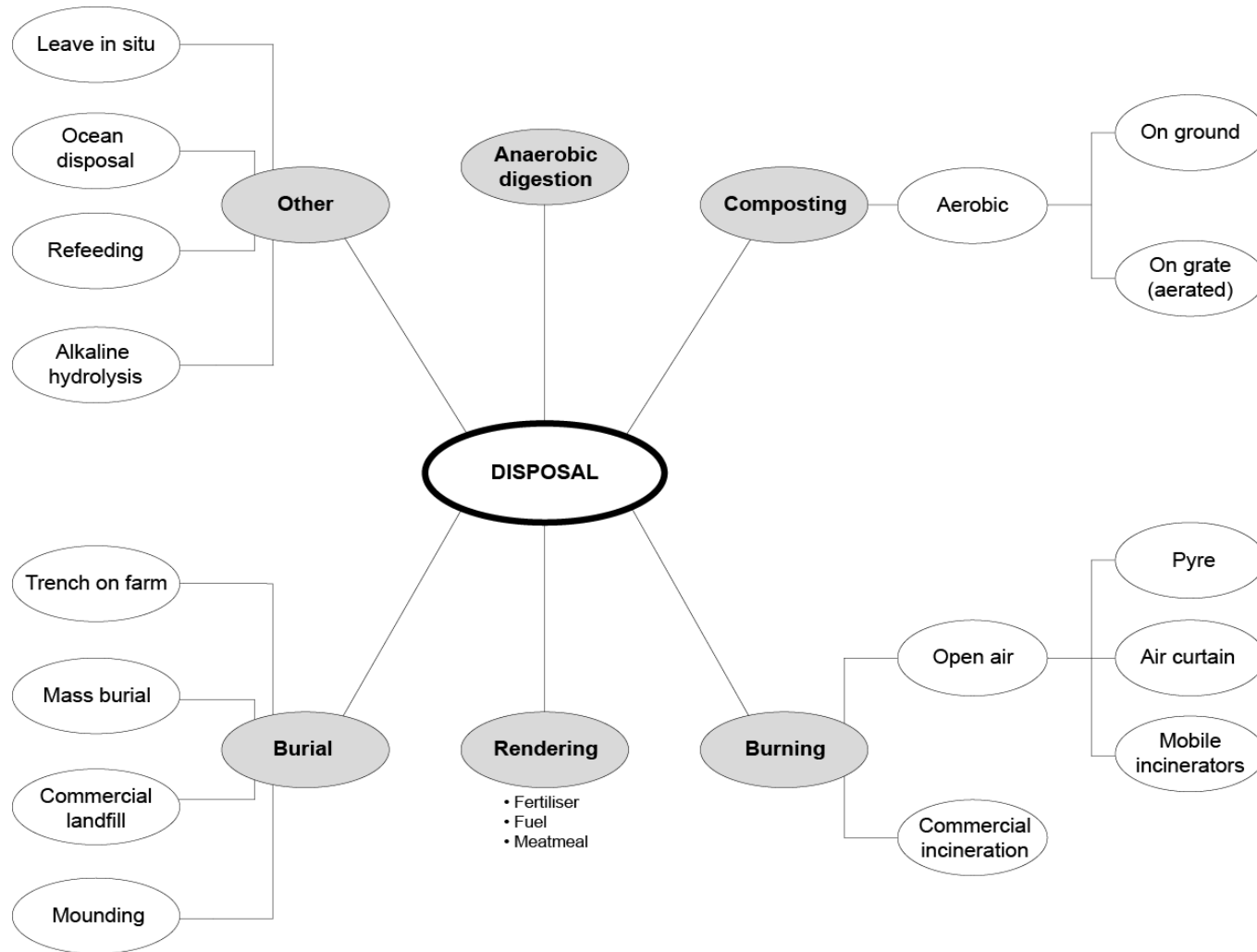

Figure 4.1 Disposal methods

4.2 Burial

4.2.1 Process overview

Carcasses of all classes of stock and other contaminated materials (such as litter and manure) can be disposed of by burial if suitable site(s) are available. The main categories of burial are described below.

Trench burial on-site

Trench burial involves the excavation of a trench into the earth, placing of carcasses and other materials in the unlined trench, and covering the materials (backfilling) with excavated earth. Typically, this takes place on the site where animals originate.

Commercial landfill

Use of commercial landfill involves the use of a highly regulated pre-existing waste disposal facility, typically designed with sophisticated byproduct (methane and leachate) management systems to protect the environment.

Mass burial

Mass burial is used when large numbers of animal carcasses from multiple locations are disposed of. It may incorporate the use of sophisticated byproduct management systems. Unlined burial is usually used when soil types or local geology can control the risk of leachate leakage, whereas lined burial is used when there are risks of leakage of leachate into subsoil or the watertable. Typically, these sites are not at a pre-existing waste facility; however, the burial site location may have been previously assessed for this purpose.

Mounding (above-ground burial)

Mounding (above-ground burial) involves placing carcasses on a natural surface of earth and covering them with earth obtained from another source. Typically, this takes place on the site where animals originate. There will be byproducts of decomposition to manage.

A number of environmental, work health and safety (WHS), and future land-use matters need to be considered, and the appropriate authorities (such as state or territory environment protection agencies, local councils and agencies responsible for WHS) should be consulted before a site and disposal method are chosen. Issues such as post-burial site management and environmental monitoring should also be discussed with stakeholders and regulators, such as the responsible local government and environmental agencies.

In most circumstances, the construction and burial process will be carried out by contractors. Site logistics should be discussed in detail with prospective contractors or others carrying out the process.

Lime (calcium oxide) has been used for centuries in agriculture as a disinfectant, and in burial pits to increase the rate of decomposition of carcasses. It is now known that the disinfectant properties of lime are due to its ability to raise the pH. A pH above 10 will disrupt bacterial cell walls and hydrolyse viral genome nucleotides. Unfortunately, this counteracts the acidification of carcasses that occurs naturally as part of the decomposition process and destroys many disease organisms. In addition, it has been shown recently that

calcium preserves anthrax spores (Himsworth 2008). Hence, addition of lime to burial pits is not recommended.

4.2.2 Disease agent considerations

Burial is a biosecure disposal method for most EADs. Exceptions are anthrax, for which deep burial is contraindicated because of the persistence of anthrax spores in soil, and transmissible spongiform encephalopathies (TSEs), which require specific heat treatment to denature the infectious prions.

The biosecurity requirements and logistics of transporting carcasses and other materials to a suitable burial site should be carefully considered.

4.2.3 Volume of material for disposal

The amount of material to be disposed of and the number of locations from which it will be sourced will have an important bearing on which burial method is used. Trench burial and mounding tend to be used for on-farm burial locations when the amount of material to be disposed of is small and the number of properties is low. Some jurisdictions have weight or volume limits for material for disposal, above which the need for environmental agency approval is triggered. Use of many small burial sites on individual properties may have advantages, rather than bringing material from many sites to one large central burial site that then requires approvals. The volume or weight of carcasses and other materials to be buried from one premises may be small enough that approval from an environmental agency is not needed.

4.2.4 Location

Approval requirements will vary according to state/territory or local regulations. Consultation with jurisdictional environmental and other agencies is therefore essential. Important considerations for selection of burial sites include the criteria addressed below. For each of these criteria, the site may need to be evaluated using further on-site investigation and/or detailed map analysis. It is always preferable to have potential sites evaluated and given environmental agency approval as part of preparedness activities, rather than seeking approval during an incident.

Proximity to drinking water supply

It is preferable that the site is not in a drinking water catchment area, as defined by jurisdictional water authorities. This will prevent contamination of water supplies by decomposing animal carcasses.

Proximity to human habitation

The site should be away from towns, dwellings and major roads to reduce the risk of undesirable exposure of the public to dust, odour and unsightly activities.

Soil characteristics

The site should preferably be on soils of low permeability (any soil with significant clay content). Even pits in clay soils should have their bases compacted during construction because fissures and porous sandy inclusions are a common occurrence. Where soils are not of low permeability, efforts should be made to stockpile clay from excavations or obtain clay from nearby sources for use in lining the pit base.

If there are issues with soil permeability, consideration should be given to lining pits. This reduces the likelihood of contamination of the watertable by leachate.

Groundwater depth

The seasonal maximum groundwater level at the site should be below the base of the burial pits, whose level should be determined and approved by environment protection agencies. This will also reduce the likelihood of contamination of the watertable by leachate.

Proximity to surface water

The site should be away from any watercourses, lakes, ponds and so on, to reduce the likelihood of contamination of water systems by leachate and runoff. This includes natural or dammed fresh water, aquaculture ponds, tailings ponds, sewage treatment ponds, reservoirs and water tanks. The distance from the watercourse needs to be approved by the environment protection agency.

Proximity to coast

The site should be a sufficient distance from the coast to reduce the likelihood of coastal contamination by leachate and to avoid areas that are heavily used for recreation. As well, sandy soils near the coast are very permeable.

Proximity to World Heritage areas, conservation areas and Indigenous cultural sites

The site should be a sufficient distance from World Heritage areas, conservation areas and Indigenous cultural sites (including midden sites) to preserve the values associated with these sites. Distances vary according to state/territory and local regulations; environmental agencies should be consulted.

Site accessibility

The site should be accessible to trucks and earthmoving equipment, allowing them to enter easily and be effectively disinfected.

Site terrain

The site should preferably not be on a slope greater than 6% and should allow digging of 5-metre deep pits with heavy equipment. This is a logistical constraint associated with construction of burial pits.

Site area

The site should be of sufficient size to accommodate the required burial activity without affecting neighbours.

4.2.5 Environmental implications

Environmental implications of all burial categories, including trench burial and mounding (which carry smaller risks), are potentially serious and are detailed in Section 3.4. Environmental implications of lined pits, although less than for most unlined pits, are not insignificant; the site must be monitored to ensure that the integrity of the liner is maintained.

Environmental implications for an established commercial landfill facility will already be part of the facility's management planning.

Leachate production

Leachate is the liquid that is released during the decomposition of wastes. It has been estimated that 50% of the available fluids will leak out of carcasses within the first week following death, and nearly all fluid will drain from the carcasses in the first 2 months. Following the outbreak of foot-and-mouth disease (FMD) in the United Kingdom in 2001, it was estimated that 170 litres of fluid was released in the first 2 months by an adult cattle carcass, and 16 litres was released from an adult sheep carcass (UK Environment Agency 2001).

The potential for leachate to cause long-term problems is significant, especially for putrescible mono-fill disposal pits for carcasses. Effective leachate management must be included in early planning, such as by the inclusion of drainage to collection points in pit bases, with inspection points and pump-out wells installed at appropriate locations, depending on pit design.

Leachate can potentially contaminate surface water and groundwater supplies. Advice must be sought from relevant environment protection agencies on the programs required for containment, treatment and monitoring of leachate.

Gas production

Gas production from decomposition within unopened carcasses may result in a considerable increase in the volume of the buried material, to the extent that the surface of the closed pit may rise, and carcasses and/or leachate may be expelled. However, WHS and biosecurity considerations may outweigh the benefits of slashing the rumens of carcasses to prevent them from bloating and surfacing. Carcasses should not be slashed before transport. A small puncture hole can be made in rumens at the side of the pit before the carcass is placed in the pit. Alternatively, attachments on excavating equipment can be used to puncture carcasses when this is considered necessary. Under no circumstances should personnel enter the pit during filling. Where mass burials occur, the gas trapped under the cover of soil can be vented through pipes for treatment.

4.2.6 Remediation requirements (including monitoring)

Remediation requirements for trench burial and mounding will depend on local environmental regulatory requirements.

Regular inspection of unlined mass burial sites after closure is recommended so that appropriate action can be taken in the event of movement of leachate in the soil profile or other problems. The objective is to return the site to its original condition. Advice on the need for an ongoing environmental monitoring program for burial sites will need to be obtained from the relevant environment protection agency during the planning stage.

Inspections of lined burial sites after closure may be less frequent than for unlined sites. However, advice on the management and treatment of leachate, and the extent of environmental monitoring will need to be obtained from the relevant environment protection agency.

Remediation requirements for a commercial landfill facility will already be part of the facility's management planning.

4.2.7 Time considerations

Trench burial and mounding are the least time-consuming burial methods when small numbers of infected properties are involved. After site environmental risks have been considered, operational issues are more time efficient because of low resource needs, including low transport requirements.

For **mass burial**, selection of a site that is not currently used for that purpose will inevitably involve some delays before burial activities can take place. For many EADs, destroying affected animals is a high priority to stop the production of the disease agent. Depending on the weather conditions, there is a practical limit on how long animal carcasses and other materials can be left before being transported to an approved and constructed burial facility. This imposes limits on the usefulness of a large-scale, approved site for disposing of animals destroyed early in an emergency response. As mentioned in Section 3.4, well-planned prior agreements with environmental agencies can reduce the approval time, to allow deep burial to occur within practically functional periods.

Lining or partial lining of pits and use of absorbent layers may help to control the generation, release and degradation of leachate that may affect groundwater resources. It may allow use of sites where subsoil structure or deep groundwater has not been fully evaluated. This may reduce the time between site identification and use, if materials to line the pit can be sourced promptly. In most cases, significant time is needed to obtain materials to line burial pits.

Using a **commercial landfill facility** will have significant time advantages because approvals, construction, access and security facilities are already in place. Resources such as power, water, lighting and on-site machinery are often also available. Environmental risk management measures will usually already have been carried out.

Methods to mitigate leachate issues include using clay from excavations or nearby sources to put in place a compacted and channelled clay base, use of high-density polyethylene (HDPE) liners, and placement of absorbent layers of wood chips or hay.

4.2.8 Cost considerations

Trench burial and mounding will generally require less infrastructure and personnel, and will therefore have lower costs. The cost of excavation, access and security will need to be included.

For **unlined mass burial**, there are two main cost categories to be considered:

- Immediate costs include site evaluation, provision of access, construction of facilities and security, carcass transport and site burial works. It is likely that many of these operations will be carried out by contractors.
- Longer-term costs of rehabilitation of the site include monitoring movement of leachate in the soil profile, and monitoring for contamination of water or other sensitive environmental assets.

For **lined mass burial**, the longer-term costs of rehabilitation of the site, including monitoring, need to be considered. There may be a much lower risk of movement of leachate from the pit, and therefore a reduced need for monitoring of the site and surrounds. However, the cost of facilities to manage and treat leachate will need to be added.

The cost of using a **commercial landfill facility** can usually be established quickly, thus avoiding complex costings of unbuilt and unapproved sites.

Economic modelling of all cost issues, including transport, site costs and ongoing monitoring costs, will inform decisions about the most suitable burial method(s).

4.2.9 Resource requirements

The following important issues relating to resource requirements are common to all categories of burial.

Supervision

The burial site will be managed by approved infected premises site supervisory (IPSS) personnel, who are responsible for all activities being carried out at the burial site. All personnel on the site must have been inducted. Since burial activities may carry significant safety risks, an officer with good knowledge of WHS principles should be appointed for the site.

When using a commercial landfill facility, the existing site workforce is usually available and familiar with working on the site. Personnel will need to be trained in biosecurity procedures, including safety procedures, by infected premises security (IPS) personnel. IPS personnel retain responsibility for biosecurity procedures.

Burial works

The activities of pit construction and burial works can be conducted by contractors. The expert team (see Section 2.4) can decide the specifications of the contract, and IPS personnel can directly supervise the contractors. In most cases, contractors will arrange their own resources and include the supply of these in the contract price.

For lined burial, sourcing of suitable pit liner and equipment to install it is the main additional activity required before burial works commence.

When using a commercial landfill facility, burial works will usually be conducted by employees of the existing facility on a contract basis. The specifications of the contract will be decided by the expert team. The facility will normally have, or have access to, its own resources. IPS personnel will be responsible for biosecurity at the site.

Site security (people and uncontrolled animals)

For **trench burial**, security is normally the same as for the infected premises (IP).

For **mounding** at the site of origin of the carcasses (the IP), security will be as for the IP. Where mounding occurs at a site for disposal of carcasses and other materials from multiple IPs, security will be as for mass burial (see below).

Lined and unlined mass burial sites are likely to require perimeter security, depending on the location. Construction of security fencing for the burial site should be considered.

When using an existing **commercial landfill facility**, some base level of security will exist for the facility; this may need to be increased, in consultation with the facility's management.

Disinfection

For all burial categories, a disinfection area will need to be constructed to allow disinfection of vehicles, personnel and equipment leaving the burial site. The infected premises

operations (IPOPs) team will determine the need for resources such as disinfectant, spray units and protective clothing for this part of the burial site operations. All contractors for this function will need to be trained in biosecurity.

4.2.10 Health and safety

Activities on burial sites have significant safety risks, and the safety of operational personnel is an overriding consideration. The engagement of an officer trained in WHS is a critical component of risk management. Decisions on layout, design, equipment flow and other issues that affect the safety of the site should be made by the IPOPs team, in consultation with the contractors on the site, as well as facility management when commercial landfills are used. If the cause of the emergency is a disease that is a zoonosis (eg avian influenza or Hendra virus infection), additional WHS measures may need to be taken to prevent infection of burial site workers.

Other issues to consider include the hygiene of the personnel working on the site, the availability of rescue equipment if a person falls into the pit or the pit wall collapses, and hearing and dust protection. All operations should be controlled by IPSS personnel or commercial facility personnel. Personnel should be properly trained and briefed before operations begin. Biosecurity for the site remains the responsibility of IPS personnel.

4.2.12 Advantages and disadvantages of burial

Burial category	Advantages	Disadvantages
All categories	<ul style="list-style-type: none"> Allows any number of animals of all species to be disposed of Can be initiated relatively quickly if the site has prior approval Continuous process that minimises exposure times Less visible than other disposal methods International acceptance Allows disposal of other materials Minimises odour risk 	<ul style="list-style-type: none"> Potential risk to groundwater Requires suitable geology and land area Likely to require ongoing site monitoring Requires biosecure transport of materials to a site WHS risks for large operations (large equipment required) Leachate and gas may need to be treated Potential local community resistance May affect future use and rehabilitation of the site Requires timely availability and acceptable cost of suitable equipment Not suitable for urban areas or near human habitation (unless it is a commercial landfill facility)
Trench burial on-site	<ul style="list-style-type: none"> Can be initiated relatively quickly on the site where animals are destroyed Relatively low equipment requirements Volume or weight of carcasses and other materials to be buried from one premises may be small enough that environmental agency approval is not needed Usually fewer WHS risks because of the size of the operation and equipment used 	<ul style="list-style-type: none"> If many properties are involved, many suitable sites will be required Number of carcasses able to be disposed of is lower than for mass burial method May limit future land use on farm
Commercial landfill	<ul style="list-style-type: none"> Sites may already be licensed to accept animal waste On-site facilities (power, water, machinery, personnel, security, decontamination facilities) are already in place Environmental protection measures are already designed and implemented (eg infrastructure to treat leachate and gas) WHS protocols and security arrangements are already in place Many facilities are on government-owned land; therefore government manages the risks 	<ul style="list-style-type: none"> Sites may not be in a suitable location to minimise risks associated with transport of infected carcasses and other materials Sites may not have capacity for burial of large volumes of animal carcasses and other materials May exhaust a local resource

Burial category	Advantages	Disadvantages
Mass burial (unlined)	<p>Can be initiated relatively quickly if the site has prior approval</p> <p>Can be undertaken on suitable land close to the animals that need to be disposed of</p> <p>May be able to be used for large numbers of carcasses (tens of thousands)</p>	<p>Difficult to engage specialised engineering and waste treatment personnel in a timely manner</p> <p>Requires careful management of WHS risks for large operations with significant equipment</p> <p>May require treatment of leachate and gas</p>
Mass burial (lined)	<p>Less strict requirements for suitable impermeable soils</p> <p>Lower environmental risks from leachate leaking from the burial pit</p> <p>May be able to be used for large numbers of carcasses (tens of thousands)</p>	<p>Suitable lining material is difficult to source and can be technically difficult to install</p> <p>Sourcing lining materials can lead to delays</p> <p>Difficult to engage specialised engineering and waste treatment personnel in a timely manner</p>
Mounding (above-ground burial)	<p>Can be initiated relatively quickly on the site where animals are destroyed</p> <p>Relatively low equipment requirements</p> <p>Volume or weight of carcasses and other materials to be buried from one premises may be small enough that environmental agency approval is not needed</p> <p>Carcasses and other materials can be disposed of rapidly</p> <p>Usually fewer WHS risks because of the size of the operation and equipment used</p>	<p>If many properties are involved, many suitable sites will be required</p> <p>Fluids from decomposition will need to be managed</p> <p>Higher risk of serious odour issues if carcasses and other materials are not covered effectively</p> <p>Requires large amounts of soil to cover carcasses and other materials</p> <p>May limit future land use on farm</p>

WHS = work health and safety

4.3 Burning

Burning or incineration ('thermal treatment') is a waste treatment process that involves the combustion of organic substances contained in waste materials. This process converts waste materials into ash, gas and heat.

There are two broad categories of burning methods:

- open-air burning
- commercial incineration.

4.3.1 Process overview

Open-air burning

Open-air burning involves the burning of carcasses in an open setting (outdoors), using combustible materials as a primary fuel source. This category includes pyre burning, below-ground air-curtain incineration (pit burning), above-ground air-curtain incineration (fireboxes) and use of small mobile incinerators (gas fired). Gas-fired mobile incinerators are not readily available in Australia and have limited throughput capacity; these are not addressed further in this manual.

Fuelgel can be used as a fuel source to initiate combustion.

Pyre burning

Pyre burning involves burning carcasses on 'pyres' constructed of solid fuels such as dry wood or coal briquettes. The carcasses are placed on top of the solid fuel, ensuring that there is sufficient airflow around them for efficient combustion. The pyre design and the quality of the solid fuel used will determine the efficiency of combustion. Generally, the more efficient combustion, the less smoke generated and the greater the temperature achieved. For further details on how to construct a pyre, refer to Appendix 7.

Air-curtain incineration

Air-curtain incineration (Figure 4.2) involves burning materials in either an earthen pit or a metal refractory box (firebox) using fan-forced air. A machine forces a mass of air across the length of the pit or box, creating a turbulent environment that greatly enhances incineration. The angle of the airflow results in a curtain of air acting as a top for the incinerator and provides oxygen, which results in a more complete burn. Unburned particles are trapped under the curtain of air in the high-temperature zone, where temperatures can reach 1000 °C (1832 °F).⁵

⁵ www.airburners.com/principle.html

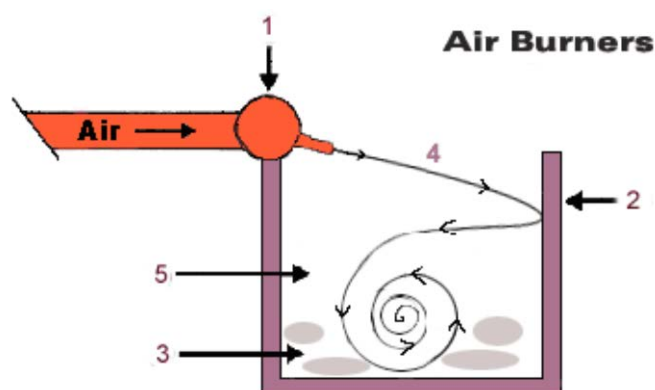

1. Air curtain machine manifold and nozzles direct high-velocity airflow into refractory lined firebox or earthen pit.
 2. Refractory lined wall (firebox) or earthen wall (pit burner).
 3. Material to be burned.
 4. Initial airflow forms a high-velocity 'curtain' over fire.
 5. Continued airflow oxygenates fire, keeping temperatures high. Higher temperatures provide a cleaner and more complete burn.
- Source: Air Burners Inc (www.airburners.com)

Figure 4.2 Theory of air-curtain incineration

When operating an air-curtain incinerator, solid fuel (eg dry wood) is loaded by an excavator into the receptacle to establish a base fire. Once the base fire is established, the solid waste (carcasses) can be loaded onto the fire. This process can be monitored by observing the volume of smoke leaving the receptacle and adjusting the fuel-to-waste ratio accordingly.

Fuelgel

Fuelgel – a combination of a powdered aluminium soap and a hydrocarbon – is a fuel source that has been trialled for burning carcasses in Australia. Fuelgel is routinely used by fire agencies in aerial drip-torch operations for prescribed burning (eg hazard reduction burning). More recent liquid gelling products appear to be more operator-friendly than previous solid powder gelling agents.

Findings from Australian trials (Worsfold and King 2006) indicate that fuelgel is more appropriate as a secondary fuel source during initiation of a timber pyre burn than as a stand-alone primary fuel source. Fuelgel is not as volatile as straight hydrocarbon products (eg petrol and diesel) and has a more sustained burn time, making it particularly useful for starting long timber pyres.

Commercial incineration

Commercial incineration (fixed facility incineration) involves the combustion of waste materials in contained and usually highly controlled chambers, which are typically fuelled by gas. This is considered an efficient and safe method of disposing of contaminated waste. This category includes waste incineration plants, pet crematoriums, small on-farm incinerators, cement plants and power plants.

Waste incineration plants are usually located in populated centres and are primarily designed to handle small quantities of material (eg medical waste, quarantine waste and deceased pets). The facilities are usually well set up to transport, store and handle hazardous biological materials in a safe manner. They are licensed and regulated by

environmental agencies, and their contained and controlled processes usually allow efficient high-temperature combustion and pollution control. However, because of their poor portability and often restricted throughput, their application to large-scale disposal can be limited. They are more suited to disease situations involving smaller volumes of material (eg disposal of bats, wild birds, dogs, sharps).

Using power plants or cement plants for incineration of carcasses and contaminated materials may be an option. The logistics and commercial implications will vary between facilities.

4.3.2 Disease agent considerations

Bacteria (including spore-forming bacteria), viruses, fungi and parasites should not survive any form of burning. However, the disease agents responsible for TSEs – such as scrapie, BSE and cervid wasting disease – are more durable and will survive temperatures up to 850 °C. TSE experts agree that open-air burning should not be considered a legitimate disposal option for TSE agents (SSC 2003). However, because commercial incineration is highly controlled, the required 850 °C is obtainable. Air-curtain incineration can also achieve the required temperature, but the temperature can depend on the efficiency of the system.

4.3.3 Volume of material for disposal

The volume of material to be disposed of may directly affect the method of disposal. Because burning is a more resource-intensive method with regard to labour and other inputs than some other disposal methods, it may not be suitable for EAD responses involving large volumes of material. This will not be the case where there is a disease imperative for burning carcasses (eg anthrax).

4.3.4 Location

Factors affecting where a burning operation can proceed will depend on the type of waste materials and the chosen method.

Open-air burning

Proximity to neighbours

Depending on the size of the operation and the materials to be disposed of, burning can affect surrounding neighbours and roads. Impacts can include the presence of smoke and odours, and reduced visual amenity. Impacts can be reduced through appropriate siting of operations on the property, good design and management of pyres or pits, and effective communication with neighbours and property owners.

Availability of fuel

A suitable and cost-effective supply of solid, liquid or gas fuel is required. Other disposal options should be considered if fuel is severely limiting, unless there is a disease imperative (eg anthrax).

Fire risk

Personnel should ensure that all possible controls are implemented to reduce the risk of fire spread (eg adequate cleared area, adequate supervision, presence of firefighting capability, fire permits, notification of burn times).

Infrastructure

Identification of underground and above-ground utilities should be part of any initial property risk assessment.

Site access

Good access is required to deploy machinery to supply fuel, construct the pyre or pit, maintain the fire and dispose of ashes.

Commercial incineration

Availability

Commercial facilities may not be available in some areas; smaller facilities may be available in peri-urban areas.

Transport

Adequate transport methods will be required to enable access to the site for personnel and materials.

4.3.5 Environmental implications

Effects on air quality

The nature of emissions from open-air burning depends on many factors, including fuel types and efficiency of combustion. Risks associated with open-air burning were the subject of studies during the FMD outbreak in the United Kingdom (UK) in 2001. The fear of dioxins and smoke inhalation, along with the generally poor public perception of pyres, eventually led to discontinuation of the use of mass burn sites in the UK. However, pollution levels never exceeded levels in other urban parts of the UK, did not violate air quality regulations and were deemed not to have unduly affected public health (NABC 2004). Properly operated commercial and air-curtain incineration methods pose fewer pollution concerns than pyre burning (Ford 2003).

Groundwater pollution

Open-air burning can pose risks to groundwater, although this is usually only if liquid fuels are used for initiating burns.

Soil and food pollution

Dioxins and polychlorinated biphenyls (PCBs) are known to emanate from pyres. During the UK FMD outbreak in 2001, the UK Food Standards Agency confirmed that levels of these two pollutants, with a few exceptions, were within the normal range throughout the campaign and 'that no significant harm was expected from food produced near pyres' (Cumbria Foot and Mouth Disease Inquiry Panel 2002).

Climatic conditions

Significant rainfall events can limit combustion efficiency.

Responsibility for environmental controls

For commercial incineration facilities, environmental considerations (air, water, soil and food) have been accounted for by the facility operator.

4.3.6 Monitoring and remediation

The monitoring and remediation requirements for burning will vary according to the method used. The main environmental impacts are relatively short term and largely relate to air quality. The necessity to monitor air quality and provide site remediation should be negotiated with jurisdictional environmental agencies.

Where open-air burning is used, the main focus should be on efficient combustion and returning the burn site to a reasonable condition. Burying of ashes on-site or disposal to landfill off-site, followed by clean-up using machinery, should facilitate this process. An advantage of pit burning using an air-curtain incinerator is that the ashes are already buried, and only backfilling is required.

Typically, additional monitoring and site remediation are not required for commercial incineration methods, apart from decontamination requirements.

4.3.7 Time considerations

Factors that affect the time taken to prepare for, and complete, incineration of carcasses and contaminated materials include:

- method used
- design and capacity of the method
- proximity of the waste materials to the site (ie on farm vs off farm)
- quality and availability of solid and liquid fuels
- number and class of animals to be disposed of
- experience and availability of personnel
- type and availability of machinery
- weather conditions.

The time taken to construct a pyre will depend on the size of the pyre and the amount of machinery available. Experience from Victorian anthrax responses indicates that around 20–24 hours is required to completely burn an average bovine carcass (or small numbers of carcasses), depending on the quality of the pyre construction and how actively the carcass is managed (ie agitated). Poorly constructed pyres or pyres comprising low-quality solid fuel can significantly increase the burn time (to 3–4 days). This is in contrast to air-curtain incineration in a pit using dry wood – once set up and fully functional, this system can burn a whole bovine carcass in 90 minutes.

Commercial incineration plants can vary greatly in their capacity (tonnes per hour). They may be immediately available because there are no set-up requirements.

4.3.8 Cost considerations

The costs of open-air burning and commercial incineration can be highly variable. Costs involved in open-air burning include the supply and transport of solid and liquid fuels, contracting of machinery and personnel, and disposal of the remaining ash. The costs of commercial incineration are generally all-inclusive and include the costs of handling, transporting and treating the waste; the costs of decontaminating the facility; and the fixed costs associated with operating the facility.

4.3.9 Resource requirements

Resources required will vary with the method used and the location of the operation.

Open-air burning

Fuel

Solid or liquid fuels are required for open-air burning. Dry hardwood is the preferred solid fuel, especially for large pyres and air-curtain incineration operations. Other solid fuels such as coal briquettes can be used, but briquettes produce larger amounts of smoke because there is limited airspace between the briquettes. Briquettes can be burned more efficiently in an air-curtain operation, particularly in conjunction with wood.

Machinery

The quantity and type of machinery will depend on the tasks to be undertaken. For safety reasons, when using an air-curtain incinerator, solid fuel should be loaded into the pit or box using an excavator.

Any machinery used on an IP will need to be properly cleaned and disinfected.

Personnel

The number of personnel required will be dictated by the size of the operation. Personnel should include an IP Site Supervision function and a site safety officer. Personnel should have the required level of biosecurity training for their function.

Wherever possible, machinery rather than manual handling should be used.

Commercial incinerators

Machinery

The quantity and type of machinery will depend on the tasks to be undertaken and the facility being used. All machinery and equipment that have been in contact with contaminated materials must be cleaned and disinfected before they are returned to normal operations.

Personnel

The number of personnel required will be dictated by the facility being used. Access to the facility may be restricted to authorised personnel. Personnel should include an IP Site Supervision function and a site safety officer (possibly supplied by the facility). Personnel should have the required level of biosecurity training for their function.

4.3.10 Health and safety considerations

Activities on burning sites have significant safety risks, and the safety of operational personnel is an overriding consideration. The engagement of an officer trained in WHS is a critical component of risk management. Layout, design, equipment flow and other important decisions that affect the safety of the site should be made by the IPOPs team, in consultation with the contractors on the site, as well as facility management when commercial incineration sites are used. If the cause of the emergency is a disease that is a zoonosis (eg avian influenza or Hendra virus infection), additional WHS measures may need to be taken to prevent infection of site workers.

Other issues to consider include the hygiene of the personnel working on the site, the availability of rescue equipment, and protection from noise and dust. All operations should be controlled by IPSS personnel or commercial facility personnel. Personnel should be properly trained and briefed before operations begin. Biosecurity for the site remains the responsibility of IPS personnel.

The main health and safety issues are:

- safety of the personnel (including contractors) involved in the operation
- safety of surrounding communities.

Some of the considerations include:

- public perception of health risks associated with open-air burning (eg dioxins, particulate matter)
- weather conditions that increase the chance of fire spreading
- handling of combustible materials (eg liquid fuels)
- manual handling associated with loading of carcasses
- work being undertaken under suboptimal climatic conditions and time pressures
- existing standards for managing waste at commercial incineration facilities
- effects of working with carcasses on health (eg zoonotic diseases) and wellbeing.

4.3.11 Advantages and disadvantages of burning

Burning category	Advantages	Disadvantages
Open-air burning (pyre)	<p>Low-technology option</p> <p>Can be initiated relatively quickly</p> <p>Can be used where the watertable is high or where soil types preclude burial</p> <p>Should destroy all pathogens, except prions</p> <p>Requires only short-term monitoring</p> <p>Can accommodate all classes of animals</p>	<p>Can be time consuming and labour intensive to construct</p> <p>Requires large volumes of solid fuel</p> <p>Cost of solid fuels can be considerable</p> <p>Can take time to consume whole carcasses</p> <p>High fire risk at certain times of year</p> <p>Public perception of poor environmental outcome and disease spread risks</p> <p>Large volumes of ash will need to be disposed of</p> <p>Short-term effect on air quality (smoke, smell)</p> <p>Combustion efficiency can be affected by climatic conditions (eg rain)</p> <p>Requires 24-hour operation to maintain burning</p>
Open-air burning (air curtain)	<p>Can be initiated relatively quickly (if machine available)</p> <p>Machines are portable</p> <p>Efficient combustion achieves high temperatures and minimal smoke</p> <p>Should destroy all pathogens, except prions (unless operated at >850 °C)</p> <p>Requires only short-term site monitoring</p> <p>Burn site can be easily and quickly rehabilitated</p> <p>Lower fire risk than pyres due to better containment</p> <p>Better fuel economy than pyres</p> <p>Can be used where the watertable is high</p> <p>Can accommodate all classes of animals</p>	<p>Limited availability of purpose-built machines</p> <p>Requires suitable geology to construct the pit (not required for fireboxes)</p> <p>Requires specialist operators to manage the site</p> <p>Requires significant site controls to monitor personnel safety</p> <p>Requires active monitoring during operation</p> <p>Requires large volumes of solid fuel</p> <p>Can handle only limited volume of materials</p> <p>Public perception of poor environmental outcome and disease spread risks</p>
Commercial incineration	<p>Should destroy all pathogens, including prions</p> <p>Highly efficient and controlled combustion achieves high temperatures</p> <p>Can be initiated relatively quickly (if close to origin of wastes)</p> <p>Environmental monitoring is managed by commercial operator</p>	<p>Capacity of facilities varies — some are limited to smaller animals and/or small volumes</p> <p>Carcasses and materials need to be transported to the site</p> <p>Difficult to engage specialist operators to manage the site in a timely</p>

Burning category	Advantages	Disadvantages
	<p>Better pollution controls than other burning methods</p> <p>Management of materials by contractors is usually biosecure and safe to the operator</p> <p>No requirements for site remediation or monitoring</p>	<p>manner</p> <p>Limited location of suitable facilities</p> <p>May require pre-planning arrangements for access to a facility, or access may take some time to arrange</p> <p>Incinerator loading mechanisms (eg conveyor belts) may not be suitable for animal carcasses or easily decontaminated</p>

4.4 Rendering

4.4.1 Process overview

'Rendering is the process of heating raw materials to liberate fat from tissues and to separate fat from other solid tissues' (ARA 2011). The general rendering process uses raw materials, which are cut, mixed and cooked; protein and fat materials are then separated. Concentrated protein is dried and ground. Rendering systems produce either 'edible' or 'inedible' byproducts, and use various methods, such as wet, dry, batch, continuous, press dewatering and wet pressure rendering (Auvermann et al 2004). Byproducts of the rendering process include meat meal, fuel, methane and fertiliser. A survey conducted by the Australian Renderers Association in 2011 revealed that there were 81 rendering plants operating in Australia (ARA 2012).

4.4.2 Disease agent considerations

When considering rendering as a disposal option during an EAD response, the capacity of the rendering process to effectively destroy the causative organism must be determined. Treatment parameters (heat, pressure, time) may vary from facility to facility. Useful references include AUSVETPLAN **Disease Strategies** and the AUSVETPLAN resource document *Persistence of disease agents in carcasses and animal products* (Williams 2003).

4.4.3 Volume of material for disposal

The volume of material able to be disposed of through rendering will vary between facilities. It may be affected by the operator's need to maintain normal business with other clients.

4.4.4 Location

The proximity of the rendering facility to the affected premises must be evaluated. Where travel distances are large, or the only possible route is through intensive agricultural sectors or townships requiring biosecure transport, additional time and costs will be involved. Rendering facilities that are associated with unaffected industries or areas may not be available for use.

4.4.5 Environmental implications

Odour and wastewater are the major byproducts of the rendering process that have the potential to pollute the environment. Industry standards provide guidelines for best-practice containment and treatment of these products. Commercial operators have licences from environmental agencies that cover these aspects.

4.4.6 Monitoring and remediation requirements

Not applicable.

4.4.7 Time considerations

The capacity of the facility (number of carcasses able to be processed per day) will determine the time taken to dispose of carcasses. In a large EAD response, the availability and capacity of rendering need to be carefully assessed to ensure disposal within reasonable timeframes. Freezing or chilling of materials may allow disposal over a longer timeframe, but will increase costs (Pluimers et al 1999) and may increase the risk of dissemination of disease as a result of increased handling requirements.

4.4.8 Cost considerations

Economic considerations, including processing costs and potential loss of trade (due to association of the plant with the disease outbreak), will need to be compared with those of alternative disposal methods. Variable costs include collection and transport of materials, storage fees, extra labour requirements and sanitation (Auvermann et al 2004). Costs will increase if markets cannot be found for the safe end products of rendering.

4.4.9 Resource requirements

The primary resource required for rendering is the facility itself. Given that the premises is established and operating to industry standards, further resources are unlikely to be needed. Further resources might include extra personnel, including an IP Site Supervision function to monitor biosecurity, and additional equipment and facilities, including water and power supply.

4.4.10 Health and safety considerations

Personnel involved in overseeing operations at a rendering facility will need to be aware of potential exposure to infectious material, noise, manual handling and machinery. Personnel will also need to be adequately trained in biosecurity procedures to prevent the spread of disease.

4.4.11 Advantages and disadvantages of rendering

Advantages	Disadvantages
<p>Existing, purpose-built facilities are available</p> <p>Facilities and process must meet industry standards</p> <p>Provides biological containment</p> <p>Produces low-risk products (eg fertiliser, fuel, methane, fats)</p> <p>Destroys most pathogens (except prions)</p>	<p>Capacity of rendering and availability of facilities may be limiting in a large EAD response</p> <p>Complexities associated with cleaning and disinfection of the facility</p> <p>Likely imposition of trading restrictions because many rendering facilities are attached to an abattoir</p> <p>Limitations on the use of meatmeal products because of prion survivability (ie ruminant feed ban restrictions)</p> <p>Limited number of facilities available, necessitating transport over long distances</p> <p>Cost is higher if there is no available or accessible market for safe end product</p>

4.5 Composting

Composting is a natural biological process that transforms organic materials, in a predominantly aerobic environment, into a useful and biologically stable end product. The process, if carefully implemented and monitored, generates sufficient heat to destroy most pathogenic organisms.

Composting is a proven method for disposal of animal carcasses and associated waste products. Sections of the poultry, pig, dairy and feedlot industries in Australia use composting for on-farm disposal of mortalities that occur under normal production circumstances.

4.5.1 Process overview

Composting can be carried out on-site or at another appropriate location (eg commercial composting facility). There are three general methods:

- Windrows – a long, narrow pile of carcasses and/or other organic, biodegradable matter is encased in uncontaminated co-compost material. The large exposed surface area encourages passive aeration. Dimensions can be adapted to any size and number of carcasses.
- Bins – an enclosure with at least three sides on a hard stand is used to contain compost materials, which may be covered by a roof. Hay bales may offer a temporary option.
- Vessels – composting material is enclosed in a sealed chamber or vessel, where environmental parameters such as temperature and aeration can be better controlled. Examples are Ag Bags and rotary composters.

The composting process involves either layering or mixing carcasses with co-compost material. The first stage is characterised by increased temperatures and rapid rates of decomposition. These conditions result in the elimination of odours, the destruction of most pathogens and weed seeds, soft tissue decomposition, and the partial softening of bones. Compost piles will reach temperatures sufficient to kill most pathogens in 10-14 days for small carcasses (eg poultry), but longer for larger carcasses. Piles must be monitored for temperature, and the sinking or cracking of cover material. Temperatures decrease at the end of the first stage.

The second stage has lower rates of biological decomposition, and its management will have an impact on the suitability of the end product. The pile can be moved, turned or mixed at the end of the first stage. Turning piles may increase the rate of decomposition of remaining materials (mainly bones) by increasing aeration, therefore reducing compost time. However, it may be associated with biosecurity risks.

The finished product can be recycled, stored or added to the land as a soil amendment. State or territory regulations may affect the final use of the product. Consideration should be given to testing the disease status of the product before it is released for use.

Commercial composting facilities operate in all states but may not be licensed to accept EAD materials for composting or have the required capacity.

4.5.2 Disease agent considerations

Composting is a well-established method of pathogen reduction. It destroys nearly all pathogenic viruses, bacteria, fungi, protozoa (including cysts) and helminth ova. Exceptions are the endospore-forming bacteria (eg *Bacillus anthracis*) and prions (including BSE).

Australian research has shown that Newcastle disease virus strain V4 inoculated inside poultry carcasses was killed during composting after 1 day of exposure to temperatures above 45 °C (Wilkinson et al 2014). This finding is supported by other published studies showing that both avian influenza and Newcastle disease viruses are quickly inactivated when composting temperatures reach 40–50 °C (Guan et al 2009).

4.5.3 Volume of material for disposal

The volume of material (carcasses and other contaminated material) that can be disposed of will be affected by the availability of suitable areas for composting, and the ability to source appropriate co-composting materials.

4.5.4 Location

Composting can be completed either inside or outside sheds.

In-shed and vessel composting provide security and protection from wind, rain and scavengers. The logistics of in-shed composting will vary from situation to situation. Older sheds with pillars or with little floor-to-ceiling clearance may prove to be more difficult, since manoeuvrability is restricted, and composting piles will need to be constructed between the pillars.

Locating composting outside sheds (in windrows or bins) requires land with an adequate slope (to facilitate proper drainage and prevent water pooling), all-weather access and security (from people and scavengers).

Commercial operators may not be available in rural or remote areas.

4.5.5 Environmental implications

Odour

When conducted properly, composting should not result in excessive odour problems. Peak odour emissions occur during the turning of composting piles (if conducted), although these usually settle down quickly when turned piles are re-covered with new co-composting material.

Groundwater pollution

Composting should not result in pollution of groundwater, provided that the depth of the base layer is sufficient. Any leakage of fluids from piles should be immediately attended to by the addition of more absorbent co-compost material. Care should be taken not to overwater compost piles. It is better to err on the side of caution and have a drier mix than to have an overly wet one.

Soil contamination

The top layer of soil under the piles may contain higher nutrient concentrations than surrounding areas, where the compost base layer has not absorbed all fluids from piles.

Climatic conditions

Significant rainfall events can affect outdoor composting systems. Additional co-compost material or a cover (eg silage covers) may be needed to prevent excessive rain damage.

Composting in cold temperatures may increase the time taken to reach suitable temperatures.

4.5.6 Monitoring and remediation requirements

Monitoring is mainly required during the composting process itself, and includes monitoring of compost temperatures, leachate and odour. Monitoring of compost, or sites where composting has been conducted, is not normally required after the process has been completed.

Acceptable uses for the final compost product need to be determined. The finished product may need to be tested for nutrient composition and microbiological profile.

4.5.7 Time considerations

Composting can be immediately set up on-site if adequate co-composting material is available. Off-site composting at a commercial facility usually requires more organisation but may reduce the quarantine period on an IP.

The time to completion of composting varies with the size of the animals, the co-compost material and management of the pile (eg turning, mixing and watering) (Wilkinson 2006). Generally, the larger the carcass, the longer it will take to compost. Keener et al (2000) concluded that decomposition times are largely a function of carcass mass, and reported weight-based prediction equations for the duration of the primary and secondary phases of composting, as well as windrow height and base measurements for optimal performance.

The first stage of composting is usually complete within about 3 weeks for poultry, and up to 12 weeks for larger carcasses. The second stage takes an additional 3 weeks for poultry and up to about 8 months for larger animals (but this will vary). Composting in sheds will affect the period for which the facilities will be out of production (CFSPH and USDA 2012)

Pre-treatment of carcasses (eg by grinding) will reduce compost times and co-compost material volumes, but will increase biosecurity risks.

4.5.8 Cost

The cost of a composting operation can be highly variable. Costs include the supply and transport of co-composting material, contracting of machinery and personnel, and disposal of the end product. Costs will be subject to availability of resources and location of operations. Commercial operators (where available) may be a less costly option.

4.5.9 Resource requirements

Co-compost material

The depth of litter on the floor of a poultry shed in Australia (typically around 50 mm) is unlikely to be sufficient in most cases to set up a composting process without importing additional co-composting material (Wilkinson et al 2014).

Green sawdust is probably the most commonly used co-composting material, as it is highly absorbent and promotes high temperatures for prolonged periods. It is also currently widely used in Australia as bedding material in poultry sheds. However, other co-composting materials can be successfully used, depending on cost and availability. Some of these other options are pine shavings, sawdust/shaving mixes, uncontaminated poultry litter, rice hulls, straw and green waste.

Sourcing and delivery of co-composting material may be difficult, particularly in remote areas.

Equipment

Composting requires sufficient and suitably sized earthmoving equipment that has adequate reach to safely build piles or load bins. Equipment is also required when piles are turned or moved.

Stainless steel compost temperature probes or data loggers are required to monitor composting on a regular basis, especially during the first stage of composting. Probes and data loggers should be calibrated before use.

Personnel

Skilled operators of earthmoving equipment are essential. Personnel experienced in the composting process – for example, in routine mortality composting (eg farm managers) – would be an advantage.

4.5.10 Health and safety considerations

Some of the WHS considerations include:

- working with co-compost material and carcasses, which may create airborne particulates, requiring suitable personal protective equipment
- manual handling by personnel assisting in the composting process
- community safety
- public perception of health risks
- working around large machinery or in enclosed sheds.

4.5.11 Advantages and disadvantages of composting

Advantages	Disadvantages
<p>Low-technology disposal method</p> <p>Can be done either on-site or off-site</p> <p>Can be used where a high watertable or unsuitable soil types preclude other disposal methods</p> <p>Commercial operators are available</p> <p>Destroys all pathogens except endospore-forming bacteria (eg anthrax) and prions (eg BSE)</p> <p>Can be initiated immediately if adequate co-composting material is available</p> <p>Recycles carcasses and results in a saleable product (subject to acceptable use)</p> <p>Can take all livestock, suitable fomites and some industry products</p> <p>Does not require long-term monitoring or remediation</p> <p>Promotes an environmentally responsible image</p>	<p>May require a large area</p> <p>May require a large supply of co-composting material</p> <p>Possibility of localised odour and soil contamination if poorly managed</p> <p>Requires daily control and monitoring during initial stages</p> <p>Biosecurity risk if required temperatures are not achieved</p> <p>May take longer than other disposal methods, which may affect release of quarantine (if conducted on-site)</p> <p>Efficiency may be affected by adverse climatic conditions</p> <p>Limited experience in mass mortalities of large carcasses</p> <p>No data for composting of livestock with heavy fleece</p> <p>Potential local community resistance</p> <p>Transport required for off-site or commercial composting</p> <p>Access to commercial composters may require pre-planning or additional time to arrange</p> <p>May require final product testing to release compost</p>

4.6 Anaerobic digestion

Anaerobic digestion facilities are being built on farms to convert animal effluent to biogas (methane), which is then used for heating and/or electricity generation. Similar facilities could be used in the event of an EAD outbreak for the disposal of effluent and carcasses (NABC 2004).

4.6.1 Process overview

The process of anaerobic digestion involves the use of a mixed bacterial ecosystem, without oxygen, to transform organic material into methane, carbon dioxide and a sludge. Initially, hydrolysis breaks down lipids, polysaccharides, proteins and nucleic acids into fatty acids, monosaccharides, amino acids, and purines and pyrimidines. Acetogenic bacteria convert these to organic acids, carbon dioxide and hydrogen. The organic acids are then converted to methane and carbon dioxide. A balance between the various microbial populations must be maintained during this process.

4.6.2 Disease agent considerations

Pathogen containment and destruction require careful consideration. Thermophilic organisms can be used in the digestion process to achieve temperatures of around 55 °C. An additional heating step can be included after the digestion is complete to inactivate pathogenic organisms that survive the digestion process (NABC 2004). This process is not suitable for destruction of anthrax spores or prions.

4.6.3 Volume of material for disposal

Carcasses have a higher nitrogen content than most wastes. The resulting ammonia levels can inhibit the digestion process, and this limits the loading rate for digesters. It is estimated that digesters can handle 3.6 kg of meat per cubic metre of digester capacity per day.

4.6.4 Location

Only existing operating facilities could be used because of the time required to set up a facility, and the complexity of the facility and the process. Large-scale pig and poultry operations may have such facilities. Materials for disposal would need to be transferred to the facility.

4.6.5 Environmental implications

This process results in the formation of fertiliser and methane, both of which can be recycled. Anaerobic digesters should already have the necessary environmental approvals.

4.6.6 Monitoring and remediation requirements

The process requires continuous monitoring for optimum processing.

4.6.7 Time considerations

It takes 4–6 months to construct and start up the digester, so existing facilities would need to be used.

4.6.8 Cost

The construction, start-up and operation costs of the facilities are high. Use of thermophilic bacteria in the digestion process would increase the cost, as would the need for a final heating process for the resultant sludge.

4.6.9 Resource requirements

The process requires the construction of a digester at a considerable cost, or the use of an existing facility. Larger carcasses would need to be broken down before being placed in the digester. Optimum particle size is 5 cm diameter or less. This could result in a large labour requirement.

Digesters require water and electricity for operation. An external heating coil may be required to maintain optimum temperature.

4.6.10 Health and safety considerations

The main risks associated with anaerobic digestion relate to manual handling associated with loading and preparation of carcasses. Operators need to be trained in WHS and risks associated with potential zoonoses.

4.6.11 Advantages and disadvantages of anaerobic digestion

Advantages	Disadvantages
Produces methane, a potential energy source Produces fertiliser Eliminates most pathogens (except anthrax and prions)	Requires construction of expensive, large-scale facilities or use of pre-existing facilities, which are currently limited in number Requires storage of methane Requires treatment and management of sludge before use as fertiliser Requires electricity and water supply Not suitable for spore-forming bacterial or prion diseases

4.7 Other methods of disposal

4.7.1 Alkaline hydrolysis

Alkaline hydrolysis uses heat, pressure and an alkaline solution (sodium or potassium hydroxide) to dissolve and sterilise biological materials. It involves the hydrolysis of materials (proteins, nucleic acids, carbohydrates, lipids, etc) into a sterile aqueous solution of small peptides, amino acids, sugars and soaps. Heat is applied to significantly accelerate the process.

Alkaline hydrolysis is effective against all known pathogens (including prions). However, because of its high capital expense and relatively small throughput, its application is generally confined to specialised operations (eg research facilities, laboratories).

4.7.2 Leave in situ ('destroy and let lie')

'Destroy and let lie' could be used in extensive areas of Australia that have populations of unmusterable livestock or feral animals. The method involves leaving destroyed animals in situ, and relies on changes in temperature and pH to reduce survival of the EAD agent.

Trials have been conducted under different environmental conditions and with various species of animals. Although preliminary results to date indicate that this could be a viable technique for an extensive emergency response, further investigation in a number of climate areas will be needed before the method can be adopted routinely.

Use of this method may be possible in isolated areas following detailed risk assessments. The risk assessment should include consideration of the potential for disease spread by scavenging species, and the potential for introduction of pathogens into wild or feral populations.

4.7.3 Ocean disposal

International conventions define the conditions to be met for disposal at sea. They include the United Nations Convention on the Law of the Sea, the Convention on the Prevention of Marine Pollution by Dumping of Wastes and Other Matter 1972 (also known as the London Convention or the Marine Dumping Convention), and the 1996 Protocol to the Dumping Convention. Australia is a signatory to these conventions and protocols.

The following issues need to be considered:

- Ocean disposal could be a practical solution with fewer environmental impacts than other disposal methods.
- Although disposal at sea poses a pollution problem, this needs to be balanced against the pollution and environmental impacts of other disposal options.
- A lack of research means that there is little hard evidence to support this option.
- Ocean disposal could provide a positive contribution to the ocean food chain.
- Australia, given its large coastline and continental shelf, may be uniquely placed to use ocean disposal.
- Resourcing and logistical considerations may limit the feasibility of this method. There is significant uncertainty about the logistics, resourcing, management and personnel safety issues of handling containers of partially decomposing carcasses. A

comprehensive discussion with experts in shipping and maritime issues would be required to assess the practical feasibility of disposal at sea. Transfer sites at ports that do not disrupt other commerce would need to be identified.

- The need to prevent floating debris may require preprocessing, such as grinding carcasses, or disposal in containers.
- Disposal of animal carcasses near land may promote the presence of scavengers, which could interfere with human activities.
- This option would need to have industry, stakeholder and community support. Public opinion on disposal at sea will be a major factor in decision making. (Some level of public opposition might occur for any disposal option.)
- Use of this method would require a well-informed and robustly constructed communications plan, and a comprehensive public education campaign.
- Effects on markets and international support would need to be carefully assessed. Although Australia may have a legitimate right to use disposal at sea, it would need to take into consideration the opinions of other jurisdictions and, in particular, trading partners.
- The method would need to be thoroughly discussed and agreed with all interested parties ahead of time. It is unlikely to be an option in an emergency without prior discussion and consensus.
- From a regulatory perspective, ocean disposal is likely to be an option of last resort.

4.7.4 Refeeding to nonsusceptible species

Refeeding is the use of whole or cut-up carcasses to feed other species. It has been used in the past for feeding of animals bred for the fur trade, in hunt kennels, and for feeding of zoo collections and farmed reptiles (crocodiles). It should be noted that reptiles eat less in cooler months, and reptile farms are restricted to northern Australia.

Under Australian legislation (including legislation relating to swill feeding and restricted animal material), it is illegal to feed animal tissue to mammals, to prevent transmission of EADs.

This method would require the collection and transport of carcasses under biosecure means to the feeding point, storage of carcasses at the feeding point, and decontamination of transports. Some form of preprocessing of carcasses (grinding, breaking down) may be required.

Although refeeding is a low-technology solution, it is associated with some risk of diseases jumping between species. For example, highly pathogenic avian influenza has infected zoo tigers that were fed chicken carcasses, and BSE has infected zoo cats fed cattle carcasses. Refeeding is unlikely to be able to handle large numbers of carcasses.

5 Items requiring special consideration

All contaminated and potentially contaminated carcasses, animal products, materials and wastes should be disposed of by one of the methods outlined in Section 4. However, specific disposal considerations apply to the materials listed below.

5.1 Milk and other dairy products

Disposal of milk products presents particular difficulties because large volumes are often involved. Milk products are difficult to dispose of in effluent disposal systems because the fats in milk block screens and interfere with the aerobic digestion process.

It is essential that milk be treated to inactivate the emergency animal disease (EAD) agent before disposal (see the **Decontamination Manual**). This includes large volumes of contaminated milk in dairy farm vats, at dairy factories or in tankers. Chemicals such as formalin should not be used to treat milk because this would create a hazardous substance, reducing the options for disposal.

Treated milk could be incinerated, sprayed on pasture, fed to animals, or processed to remove a high proportion of the water content and then incinerated or buried.

In the Netherlands during the outbreak of foot-and-mouth disease (FMD) in 2001, milk from infected farms was acidified with citric acid to pH <5, rendered and then incinerated. Milk from vaccinated farms was subjected to high-temperature, short-duration pasteurisation treatment, and then heated again until a negative reaction to the peroxidase test was obtained. It was then converted to powdered milk at a designated factory (De Klerk 2002).

5.1.1 Feeding to animals

Feeding of milk, milk products, waste, surplus and out-of-date retail milk, and washings from processing plants may be possible, depending on the EAD and the risk of infecting other livestock (refer to the relevant AUSVETPLAN **Disease Strategy**). In the case of FMD, feeding untreated milk to pigs and other livestock carries a high risk of introducing FMD to a herd.

5.1.2 Spraying onto pastures after inactivation of pathogen

Milk can be treated on farm to inactivate the EAD agent – for example, with citric acid in the case of FMD virus – and then diluted and sprayed onto pastures. On-farm disposal of milk is only feasible for short periods (a few days); it would therefore need to be used in conjunction with rapid drying off or destruction of cattle (eg on infected premises).

Milk must not be permitted to run off the property, and odour could be a concern. Use of this method would require approval from the local or regional environment protection agency.

5.1.3 Composting

A few milk processing plants may already use composting for disposal of dilute dairy waste. The feasibility of composting is limited by the high fat content of milk, which may

reduce the effectiveness of composting and result in odour. The high fat content could also produce potentially phytotoxic compost if oxygen levels are not sufficient during composting, resulting in the formation of organic acids such as lactic and acetic acids. As well, the high moisture content and large volumes of milk lead to problems with transport, storage, mixing with co-composting materials and control of leachate. The feasibility of composting could be increased by first reducing the moisture content of dairy wastes – by water extraction or conversion to milk powder – followed by storage and subsequent composting of the waste (see also Section 5.1.6).

5.1.4 Burial

Milk can be buried in trenches and other carcass disposal pits, given that livestock may be culled and require disposal. However, milk is very difficult to bury, because the casein component combines with clay in soils to form a colloidal barrier that prevents absorption of the fluid fraction. This results in difficulties with sealing a pit that contains both carcasses and milk.

5.1.5 Commercial waste disposal (landfill or composting)

Use of landfill sites for disposal is limited by the high volume and moisture content of milk. The feasibility of this method could be improved by first reducing the moisture content of dairy wastes – by water extraction or conversion to milk powder – for storage and subsequent burial or composting (see also Section 5.1.6).

Before milk can be disposed of in commercial landfill or composting facilities, the outcome of treatment of the milk must be known, to ensure that the EAD agent is inactivated (preferably, milk would be treated before it is collected). This option may be limited by cost and the capacity of commercial operations.

5.1.6 Processing into milk powder for storage and subsequent disposal

Processing of milk into milk powder for storage and subsequent disposal has limited applicability because processing plants for spray drying seldom have spare capacity. Commercial plants that process milk from low-risk premises for sale may not accept milk from higher-risk premises unless contracted. A milk powder plant that is not operating at the time (because of loss of export markets) could be contracted solely to process milk from higher-risk premises, with subsequent disposal of the powder in landfill, by burial or by incineration. Memoranda of understanding may be considered for this purpose.

5.1.7 Use of central effluent wastewater disposal sites

The use of larger central sites where milk can be stored, treated and disposed of safely – for example, a retired water authority sewage treatment facility – should be considered. However, such a site may not be available during an outbreak. Milk would be treated to inactivate the EAD agent before disposal.

5.1.8 Use of tallow recyclers

Use of tallow recyclers is limited, as they may only accept high-quality fats.

5.1.9 Use of effluent ponds on farm

Use of effluent ponds for disposal raises problems due to the high biological oxygen demand of milk. However, this method may be possible where milk can be effectively and rapidly diluted. Remedial treatments to restore aerobic decomposition may be required.

5.2 Hatching eggs and hatchery waste

Before disposal of hatching eggs and hatchery waste into burial pits, all material should be macerated to ensure that live chickens are destroyed. Assistance should be sought from the poultry industry for the supply of suitable equipment and guidance on its use.

5.3 Effluent

Appendix 9 provides an overview of effluent systems and principles.

5.3.1 Effluent management during an emergency animal disease response

Effluent management during disease control activities is complicated by the increased use of large volumes of disinfectants, cleaning materials and rinse water required for effective biosecurity. Effluent containing disinfectants and cleaning material should not be mixed with the normal effluent in effluent ponds because it will disrupt the bacterial and phytoplankton population and retard the treatment process. If possible, the effluent containing disinfectant should be collected and stored separately. It may need to be treated and then disposed of by another method (eg burial, spraying on pasture, capping and closure of the pond, or off-site disposal).

The total pond storage capacity is an important criterion, as the increased volumes of chemicals and wash materials resulting from disease control measures can be considerable. Arrangements to capture and store the additional volumes may have to be made.

In the case of contagious diseases, the effluent pond and its contents pose a risk for the spread of disease. Use of disinfectants or pH modifiers (acids and alkalis) to reduce the risk may be considered.

The cost of different disinfectants and pH modifiers varies considerably. Cost will be an important consideration when deciding which disinfectant or pH modifiers to use. The effect of disinfectants and pH modifiers on equipment needs to be considered, including whether the systems and equipment in use are able to withstand exposure to such chemicals.

5.3.2 Dairy processing facilities

Effluent (such as washing water) from dairy factories presents special problems because of its volume. Chemical treatment of large volumes of effluent may render it unacceptable to a sewage disposal unit, but 0.2% citric acid should cause no problems for waste treatment. The danger of disease spread from effluent is greatly reduced by dilution, and the free use of more water than normal in the usual cleaning processes will further reduce the danger.

Where effluent is normally used for irrigating pastures, the pastures should not be grazed for at least 2 weeks after irrigation (or for the period given in the relevant **Disease Strategy**). Rennet, casein, whey or other wastes must not be sprayed over pastures, discharged into drains or fed to animals, unless treated with disinfectant as for milk.

5.3.3 Dairy farms

Effluent systems for modern milking sheds often reuse the water for cleaning yards. The large volumes of waste from wash-down and sanitisation of equipment require special attention because they are difficult to contain and decontaminate.

Dairy farms often have a well-developed effluent management systems in place. During disease control activities, the effluent, disinfectants and wash water should, if possible, be directed to a separate effluent pond, as discussed in Section 5.3.1. Milk should not be disposed of in effluent systems because of its high biological oxygen demand and the precipitation of fats.

5.3.4 Piggeries

Intensive piggeries will have well-developed effluent management plans for normal operations. The principles of effluent management described above also apply to intensive piggeries.

5.4 Manure and litter

Small amounts of solid manure may be disposed of by burial or incineration.

Composting is an effective way to deal with both manure and litter waste. Material can be composted inside sheds or otherwise on-site, eliminating the risk of spreading the EAD agent during transport. Alternatively, composting off-site – for example, at a commercial compost facility – is also an option.

Manure must be removed by biosecure transport methods. If litter is to be removed, it may be necessary to moisten the surface to reduce dust.

Manure can be stored in piles or windrows (with no co-compost material) for a period that is sufficient to destroy the EAD agent. The pile is covered to protect it from the weather and birds, and the temperature is monitored frequently to demonstrate that the pile has reached a sufficient temperature for the period required to inactivate the EAD agent. For example, avian influenza was inactivated in field chicken manure in 6 days at 15–20 °C (Lu et al 2003, Guan et al 2009). This method is usually conducted on farm and requires few resources. Consideration should be given to testing the disease status of the product before it is released for use (Lu et al 2003).

5.5 Wool and mohair

Significant research is being undertaken to investigate and approve methods that effectively decontaminate wool and mohair so that the product can be salvaged. Outcomes of this research should be carefully considered before it is decided that wool or mohair needs to be disposed of (see the **Decontamination Manual**).

If disposal is the only option, deep burial or high-temperature incineration appear to be the only effective methods.

5.6 Semen and ova

If genetic material is stored on infected premises or dangerous contact premises, its existence should be brought to the attention of the controller of the local control centre (LCC), who will determine if it constitutes a risk and must be destroyed. Because of the potential value of such material, no action should be taken to dispose of it without the express authorisation of the LCC Controller (see the **Artificial Breeding Centres Manual**).

5.7 Laboratory wastes

For the disposal of laboratory wastes, see the **Laboratory Preparedness Manual**.

Laboratory waste includes materials that have been exposed to EAD agents or other pathogens. This includes personal protective equipment, sampling equipment and sample containers.

The **Decontamination Manual** and applicable nationally agreed standard operating procedures outline the general principles of decontamination for EAD agents and other pathogens at field sites. Standard AS/NZS 2243.3:2010 (Safety in laboratories – microbiological safety and containment) describes preferred disinfection methods in microbiology laboratories.

All waste produced from an EAD response must be decontaminated or treated appropriately. In many cases, this may require sterilisation or incineration. Where adequate equipment, such as an autoclave or incinerator, is not available, plans and risk assessments should be in place for transporting waste material to a suitable facility. Any transport must comply with the requirements of relevant regulatory bodies and AS/NZS 2243.3:2010. The expected volume of waste generated will be an important consideration in these plans.

Disposal of contaminated material should follow the following procedures:

- Dispose of material as close to the laboratory as possible, to minimise the area of potential contamination.
- Where possible, bag and incinerate animal bodies and tissues on-site. Bag other laboratory waste in autoclave bags, and incinerate or deep bury it after autoclaving.
- Laboratories without direct access to an autoclave and incinerator should double bag and seal all contaminated waste at the site of handling, and thoroughly disinfect (preferably in a dunk tank) the external surface of the bags before transferring them securely for safe disposal (eg by incineration at another site).
- Double bag protective clothing. Thoroughly disinfect the surface of the outer bag before transporting it from the contaminated area for autoclaving, and subsequent laundering or deep burial.
- Soak grossly contaminated protective clothing overnight in disinfectant before laundering.
- Immerse boots in disinfectant.
- Double bag clinical waste generated in the field, decontaminate the external surface of the bags, then dispose of the bags using a suitable method, such as a licensed clinical waste contractor, burial, incineration or autoclaving.

Appendix 1 Types of potentially contaminated materials

Table A1.1 Materials that may need to be transported and/or disposed of during an emergency animal disease response

Material	Description	Comments
Acidic and basic (alkaline) solutions	Prepared solutions for treating contaminated material	<ul style="list-style-type: none"> • May require neutralising before transport and disposal
Acids and bases in solid form	Solid form of acids and bases before preparation	<ul style="list-style-type: none"> • Refer to SDS for information on work health and safety, storage, handling and disposal options
Air filters and residues from air filters	Derived from equipment, including large machinery, involved in disposal and decontamination activities	<ul style="list-style-type: none"> • Consign to licensed hazardous waste disposal agent, or treat. Treatment will depend on the infective agent. Biosecurity of transporting contaminated materials needs to be subjected to risk assessment
Animal carcasses (infected)	Assumes animals were slaughtered recently to prevent loss of significant quantities of fluid. May need to consider carcasses removed to knackeries or at abattoirs	<ul style="list-style-type: none"> • Can be very difficult to handle • Decomposition occurs quickly, within hours of slaughter (faster in summer than in winter) • Ruminants (cattle, sheep, goats, etc) begin to expand rapidly after death because of gases trapped in the rumen. Nonruminants (eg horses) pose a similar but lesser problem • Odours can cause significant public concern and may affect the willingness of workers to deal with carcasses • Leakage of materials must be avoided. Suitable liners that fit transport vehicles and can withstand loading of animal carcasses without puncturing may be required. Alternatively, leakproof vehicles can be used
Animal fluids (rumen fluid, blood, etc)	Largely viscous fluid	<ul style="list-style-type: none"> • Similar problems to animal carcasses
Animal viscera, meat and bone (infected)	Mixture of fluid and semiprocessed animal parts	<ul style="list-style-type: none"> • Similar problems to animal carcasses
Ash/remnants after burning	Remains of the funeral pyre, which may contain some incompletely burnt animal material, bones, etc	<ul style="list-style-type: none"> • Bury

Material	Description	Comments
Bedding and litter (contaminated)	Used or unused bedding and litter that may be contaminated with the disease agent	<ul style="list-style-type: none"> • Conduct risk assessment of biosecurity of transporting contaminated materials • Quantity of material may be substantial • Material may be in a solid, semisolid or liquid form • Leakage must be avoided • May be suitable for composting
Blood and bone products	Processed material that has already been put on market shelves or is destined for the market	<ul style="list-style-type: none"> • Risk assessment may be required to determine infectivity risk • Used material may require treatment to ensure that infectivity is eliminated • Procedures for recall, treatment and disposal need to be put in place
Chemical containers	Disinfectants, etc come in a variety of container shapes and sizes. There will be large numbers of these containers	<ul style="list-style-type: none"> • Check SDS for instructions on handling and storage • Triple washing of containers is considered adequate to remove most chemicals and reduce the hazard, but this depends on the chemical. Container label should identify contents • Dispose of washings from containers in an environmentally sound manner
Clinical and related wastes (including sharps)	A complex mix of material containing potentially infectious materials, sharps, etc	<ul style="list-style-type: none"> • Conduct risk assessment of biosecurity of transporting contaminated materials • Dispose of in usual way, ensuring use of biohazard disposal containers
Clothing and footwear — disposable (contaminated)	Single use or single-premises use; used in slaughter, transportation, decontamination and disposal stages of EAD response	<ul style="list-style-type: none"> • System for appropriate treatment and packing is needed before disposal
Compost	Some intensive enterprises (eg poultry units, feedlots) compost bedding, litter and carcasses. May be in large volumes	<ul style="list-style-type: none"> • Manage process and site as per standard operating procedures • Monitor compost windrow conditions and infectivity • Ownership of compost end products needs to be established at start of process • Potential markets and users need to be identified
Detergents and surface-active agents (diluted and undiluted)	Used in normal clean-down operations (refer to SDS for active ingredients)	<ul style="list-style-type: none"> • Refer to SDS and use appropriate method of disposal
Disinfectant mats	Carpet and other types of matting used on roadways and at entrances for disinfecting car tyres	<ul style="list-style-type: none"> • Usually limited numbers • Disposal at local landfill site is probably acceptable, but check state/territory regulations

Material	Description	Comments
Disinfectant wash-down water Portable shower waste	Water that may contain acids, bases, oxidising agents, detergents and surface-active agents, along with low levels of soil, etc	<ul style="list-style-type: none"> • Contain waste water in a suitable vessel (eg sump) and treat with suitable disinfectant to eliminate infectivity • Containment, treatment and disposal of wastes must be included in any EAD response program
Effluent — animal	From saleyards, abattoirs, intensive agriculture operations, etc	<ul style="list-style-type: none"> • Biologically highly active • May be in significant volumes • May be able to be disposed of to liquid waste facilities or sewerage systems, but further research is needed • May require treatment with disinfectants or other chemicals that modify pH, resulting in deactivation of microflora that normally aid decomposition • Solids from effluent may be suitable for composting
Eggs, egg pulp	May be on farm; in transit; or in packaging plants, bakeries, supermarkets	<ul style="list-style-type: none"> • Procedures for recall, treatment and disposal may need to be put in place • May require refrigeration until disposed of • Leakage must be avoided. Suitable liners that fit transport vehicles may be required. Alternatively, leakproof vehicles may be used
Equipment	Equipment considered not worth keeping once contaminated (eg personal protective equipment, including respirators, boots)	<ul style="list-style-type: none"> • May be possible to consign to licensed hazardous waste disposal operation or bury at a licensed landfill site
Feed (animal) — hay, lucerne, grain, etc (potentially contaminated)	Suspected or confirmed infective	<ul style="list-style-type: none"> • Treatment will vary with material and EAD agent
Filter cake	From sewage treatment	<ul style="list-style-type: none"> • See <i>Effluent — animal</i>
Fire debris and fire wash waters	Water used to wash fire area, or rainfall on fire area	<ul style="list-style-type: none"> • Conduct risk assessment to determine infectivity • Ensure that water does not run into groundwater drains
First-aid wastes	Bandages, bandaids, slings, etc used to treat personnel	<ul style="list-style-type: none"> • Consign to licensed hazardous waste disposal operation
Food — unprocessed, or partially or fully processed (potentially contaminated)	May be on farm; in transit; or at abattoirs, milk processing factories, pet food manufacturers, supermarkets	<ul style="list-style-type: none"> • May require refrigeration until disposed of • Leakage must be avoided
Food and drink packaging	Used on infected premises	<ul style="list-style-type: none"> • See <i>Food</i>
Food packaging	Recalled produce (eg milk cartons, meat wrappings, egg cartons)	<ul style="list-style-type: none"> • See <i>Food</i>

Material	Description	Comments
Grease-trap waste	As part of sewage or waste-stream processing	<ul style="list-style-type: none"> • Bury or incinerate
Hatchery waste — eggs	May require maceration before disposal	<ul style="list-style-type: none"> • May require pretreatment before disposal, depending on EAD agent
Hides, and partially or fully processed leather	Located on farm, in abattoirs and further down the process line	<ul style="list-style-type: none"> • Conduct risk assessment to determine infectivity • Disposal as for carcasses
Laboratory animal specimen waste	Specimens taken from infected and suspect animals for analysis	<ul style="list-style-type: none"> • Volumes will probably be greater than under normal operations • Continue to use normal disposal routes
Liners for trucks used to transport infected animal carcasses	Liners will probably require frequent replacement, so quantities of used and contaminated liners will become a disposal problem	<ul style="list-style-type: none"> • May require pretreatment before disposal, depending on EAD agent
Manure	On farms, on land, in sheds, in saleyards, in abattoirs, etc	<ul style="list-style-type: none"> • Similar issues to filter cake • May be able to be composted or beneficially used, depending on EAD agent
Meat — unprocessed or partially or fully processed (potentially contaminated)	May be on farm; in transit; or at abattoirs, knackeries, pet food manufacturers, supermarkets	<ul style="list-style-type: none"> • Procedures for recall, treatment and disposal may need to be put in place • May require refrigeration until disposed of • Leakage must be avoided
Milk and dairy products — unprocessed, or partially or fully processed (potentially contaminated)	May be on farm; in transit; or at milk processing factories, supermarkets	<ul style="list-style-type: none"> • Conduct risk assessments to determine infectivity or other risks • Procedures for recall, treatment and disposal may need to be put in place • May be treated to eliminate infectivity (treatment is essential if the material is known to be infective) • May require refrigeration until disposed of • Leakage and aerosols must be avoided
Miscellaneous items from disposal operations not listed elsewhere	All other waste not listed separately. May include equipment/housing materials that cannot be effectively decontaminated	<ul style="list-style-type: none"> • Conduct risk assessments to determine infectivity or other risks
Office wastes	Some office wastes may be confidential and will need to be secured at all times	<ul style="list-style-type: none"> • Use usual recycling, reuse and disposal methods unless contaminated
Oil/hydrocarbon and water mixtures or emulsions	May be in chemicals used to treat infected animals and materials, etc	<ul style="list-style-type: none"> • Treat and/or dispose of in appropriate and environmentally safe manner

Material	Description	Comments
Oxidising agents (diluted)	Products such as Virkon® prepared for treating infected/contaminated material	<ul style="list-style-type: none"> • If used in decontaminating equipment, ensure that all equipment is adequately rinsed, and washings are collected and appropriately treated before disposal
Pesticides — unused remnants	Incidental use of chemicals required	<ul style="list-style-type: none"> • Follow procedures in SDS or on container label • Follow relevant guidelines for disposal • Use only in accordance with label
Pharmaceuticals, drugs and medicines (surplus to use, out of 'use by' date, residual, etc)	Includes drugs used to euthanase infected, suspect or dangerous contact animals	<ul style="list-style-type: none"> • Follow appropriate normal procedures for treatment and disposal
Postdecomposition products	Safe byproduct of a chemical, anaerobic or aerobic disposal process	<ul style="list-style-type: none"> • May be a commercial product or require burying • Arrange suitable market • Ownership of compost end products needs to be established at start of process
Seeds and grain	Principally found on farm, possibly contaminated	<ul style="list-style-type: none"> • Disinfect in sealed containers
Semen and ova (infected)	Origin must be traced by following document trail from infected premises	<ul style="list-style-type: none"> • May need disinfection before disposal • Conduct risk assessment to determine exposure and/or infectivity
Sewage sludge or residues	Mainly saleyards, abattoirs and intensive operations (eg dairies, feedlots)	<ul style="list-style-type: none"> • See <i>Filter cake</i>
Soil contaminated with disinfectants, detergents, etc	Soil contaminated with chemical spillage from treatment or disinfection areas	<ul style="list-style-type: none"> • Check SDS for information on constituents and safety information
Soil contaminated as a result of the slaughter process	Contaminated byproduct of the slaughter process	<ul style="list-style-type: none"> • May require decontamination and/or disposal, depending on the EAD agent
Tallow	Found principally in abattoirs and tanneries	<ul style="list-style-type: none"> • Conduct risk assessments to determine infectivity or other risks • Bury or incinerate • Consider suitable market
Tannery wastes, including leather dust, ash sludges and flours	Specialised industry	<ul style="list-style-type: none"> • Wastes may require neutralising
Truck wash-down containing faeces, body fluids, etc	Will be an infectious material	<ul style="list-style-type: none"> • See <i>Effluent</i>

Material	Description	Comments
Vaccines (partially used or out of date), empty containers, administrative equipment	May be on farms, at control centres or at central storage sites	<ul style="list-style-type: none"> • Need to adhere to manufacturers' and licensing authority guidelines • May need decontamination before disposal • Bury or incinerate
Waste derived from processing contaminated food	Byproducts derived from processing of animal carcasses, etc	<ul style="list-style-type: none"> • May follow similar disposal path to food, effluent or filter cake
Wool scouring wastes	At fellmongers, abattoirs, etc	<ul style="list-style-type: none"> • Most organisms are unlikely to survive this treatment. Any treatment will depend on the EAD agent involved • Determine whether treatment of products and perception of continued infectivity allow for economic use of products after treatment
Wool, cashmere, mohair, feathers, deer velvet	On farm; at fellmongers, abattoirs, wool processing industries, stockpiles, etc	<ul style="list-style-type: none"> • Determine whether treatment of products and perception of continued infectivity allow for economic use of products after treatment

EAD = emergency animal disease; SDS = safety data sheet

Note: Each product will need to be classified according to local legislation relevant to waste disposal.

Appendix 2 Predisposal processing options

Some disposal options can be considered as predisposal processing methods themselves, in that they reduce or destroy pathogens, reduce moisture content, or reduce total mass before final disposal is completed using another method. Examples are composting followed by incineration, and rendering followed by burial.

Table A2.1 Predisposal processing methods

Treatment	Principle	Advantages	Disadvantages
Chemical sterilisation/ decontamination	Many AUSVETPLAN decontamination procedures are based on use of chemicals for sterilisation or decontamination. The chemicals used vary for each disease. They range from agents that simply change pH, such as citric acid and NaOH, to more powerful oxidising agents, such as Virkon®	<ul style="list-style-type: none"> • Procedures for chemical disinfection are well documented and understood 	<ul style="list-style-type: none"> • WHS concerns • Environmental concerns • Chemical needs to come in contact with organism to be effective
Heat sterilisation/ decontamination	Heat sterilisation is a well-recognised method of destroying pathogens. It can use direct sunlight, gas and electrical heating elements. Covering materials with black plastic in summer may raise temperature to required levels	<ul style="list-style-type: none"> • Uses existing technology • Available throughout Australia • Can be used immediately 	<ul style="list-style-type: none"> • Not suitable for some materials • Rendering capacity is limited • Requires monitoring to ensure required temperature is achieved throughout the material being treated

Treatment	Principle	Advantages	Disadvantages
Maceration/grinding	Maceration of carcasses and other materials will generally reduce their volume, and possibly make them easier to handle and speed the rate of decomposition/disposal	<ul style="list-style-type: none"> • Ease of handling resultant material • Different types of vehicles can be used to transport the material (eg tankers, concrete trucks) • Allows improved mixing of disinfectant products (adjuvants) with material • Increases speed of decomposition/disposal (composting/fermenting) • Increases range of possible disposal options • Large units can handle about 15 tonne/hour 	<ul style="list-style-type: none"> • Increased production of aerosols • Need for additional equipment • WHS concerns • Difficulty decontaminating equipment • Adverse owner and public perceptions • Bulking agent needs to be added to absorb liquid released from carcasses at grinding • Large labour requirement
Combined steam sterilisation and maceration	Sterilisation combined with maceration involves steam sterilising the waste and then grinding it for delivery to landfill or composting	<ul style="list-style-type: none"> • Steam sterilisation will remove most infective agents • Waste produced can be buried in landfill site that accepts uninfected putrescible waste • A portable unit can be taken on farm • Suitable for treating small ruminant and poultry carcasses • Ease of handling resultant material • Different types of vehicles can be used to transport the material (eg tankers, concrete trucks) • Increases speed of decomposition/disposal (by composting/fermenting) • Increases range of possible disposal options 	<ul style="list-style-type: none"> • Capacity is too small for large numbers of large ruminants and horses • Requires monitoring of final product • Not suitable for anthrax or TSEs • Requires skilled labour • High cost of equipment • Adverse owner and public perceptions • Bulking agent needs to be added to absorb liquid released from carcasses at grinding

Treatment	Principle	Advantages	Disadvantages
Chilling/freezing	Chilling has been used in Europe as an emergency measure to hold carcasses for later disposal. Opportunities could arise if chilling facilities at an abattoir become available because the abattoir is itself caught up in the EAD outbreak. Chilling also needs to be considered as an option for animal products to be disposed of later	<ul style="list-style-type: none"> • Quick response to a medium-scale incident • Freezers are generally easy to build. Some mobile freezers may be available from the game meat industry. Refrigerated containers may be used for short-term storage • Offers time to consider future action • Could handle carcasses and byproducts 	<ul style="list-style-type: none"> • Expensive to source and maintain • High electricity costs • Potential impact on future trading of enterprises involved • Difficult to handle whole carcasses • Rehabilitation of chiller equipment required • Freezer trucks will not freeze material not already frozen (designed to hold items that have already been frozen to -20 °C) • May not be enough refrigerated containers available in a large outbreak
Time treatment	Many pathogens responsible for causing EAD emergencies survive for only limited periods in the environment (refer to relevant Disease Strategy), particularly if conditions are hot and dry. If it is known that a pathogen will deteriorate and disappear over time, it may be more appropriate to do nothing other than restrict access to the area and wait. This is an option for remote and feral animal populations that can be isolated by distance	<ul style="list-style-type: none"> • No chemicals used • Minimal labour requirements • Low cost • Waste classification changes from hazardous to a lesser category • No transport requirements 	<ul style="list-style-type: none"> • Public perception may be negative • Some organisms may not disappear as quickly as predicted • Inability to use the property during the waiting period • Potential impact on trade • Inability to restrict access by feral animals

Treatment	Principle	Advantages	Disadvantages
Carcass breakdown (skinning, evisceration and quartering)	Some disposal options (eg rendering) require that carcasses and materials are broken down before they can be disposed of effectively. This could include: <ul style="list-style-type: none"> • skinning • eviscerating • quartering or chunking • prebreaking or grinding • slashing • removing limbs (disarticulation) 	<ul style="list-style-type: none"> • Reduces total volume of material for disposal • Speeds up decomposition or composting 	<ul style="list-style-type: none"> • Increases biosecurity risks • Increases WHS concerns • Increases resource and time requirements • Requires specific and specialised skills
Lactic acid fermentation	Lactic acid fermentation should be viewed as a means to preserve carcasses until they can be disposed of. The low pH prevents undesirable degradation processes. Carcasses are ground to fine particles, mixed with a fermentable carbohydrate source and culture inoculant, and then added to a fermentation container	<ul style="list-style-type: none"> • Decontaminates carcasses • Possibility of recycling into a feedstuff • Allows storage of carcass material • Potentially mobile process • Minimal environmental impacts 	<ul style="list-style-type: none"> • Not all pathogens are destroyed • Risk of contamination from grinding due to aerosols • Corrosion of containers • Need carbohydrate source and culture of <i>Lactobacillus acidophilus</i> • Capacity may be limited

EAD = emergency animal disease; TSE = transmissible spongiform encephalopathy; WHS = work health and safety

Appendix 3 Environmental checklist

This checklist should be used as a prompt.

Detailed consideration of many items will not be required if adequate contingency planning has taken place.

Use of an appropriate expert team, including those with local knowledge, will speed consideration of most items.

The items grouped under 'Assessment' require early consideration, whereas those grouped under 'Operational' can be considered later.

Wastes

Assessment

- Check whether the potential for beneficial reuse of the material, rather than disposal, has been assessed.
- Check that waste minimisation and management plans are in place for the activity.
- Check that all likely waste products have been classified and disposal method(s) have been identified.
- Check that biohazards posed by the emergency animal disease (EAD) agent have been assessed.
- Check that measures to inactivate the EAD agent have been identified.

Site

Assessment

- Check that the proposed sites for treatment and disposal have been identified and GPS coordinates recorded.
- Check that relevant topographical, geological and hydrological characteristics of the site have been identified.
- Check the distance of the site from population centres, and the direction of the prevailing wind.
- Check whether the site is located within an environmentally sensitive or protected area.
- Check whether use of the site is restricted or prevented by a legal instrument, planning instrument, declaration, agreement or other device.
- Check that the necessary environmental and planning approvals for the activity can be gained in a timely manner.

- Check the previous land uses of the site.
- Check if the site is potentially contaminated and, if so, consider how this can be managed.
- Check whether contamination of the site could result from the activity.
- If an environmental impact statement is needed for approval of this type of activity, ensure that the required information is available.
- Assess the risks to the local ecosystem or other wildlife, including aquatic life.
- Assess whether the activity is likely to have an impact on any future use of the area.
- Ensure that a process is planned to consult neighbours and stakeholders about the proposed activity.
- Check whether rehabilitation plans are needed for the site after the activity.

Operational

- Check whether mitigation procedures for odour or air pollution are needed and have been put in place.
- Check whether mitigation measures for noise and vibration are needed and have been put in place.
- Check whether dust mitigation measures are needed and have been put in place.
- Check plans for optimum prevention of site contamination.
- Check the need for vermin control to minimise the risk of disease transmission outside areas that are already contaminated.
- Check that environmental protection measures will be put in place during the construction phase. This is especially important if heavy equipment is used, because of the need for sediment and erosion control.
- Ensure that personnel have been adequately trained in the use of chemicals and other materials classed as dangerous goods or hazardous substances.
- Ensure appropriate security measures for environmental protection and protection of human health.
- Ensure that appropriate environmental monitoring and recording systems are in place.

Weather

Assessment

- Check that the current weather and weather forecast for the area of disposal are favourable.

Water

Assessment

- Check that surface water (rivers, creeks, lakes, dams, etc) in the area is an appropriate distance from the site, and consider containment methods.
- Assess whether surface water could be polluted or otherwise affected.
- Ensure that the surface water is not a source for drinking water supplies.
- Assess the drainage of surface water, and how receiving waterways and downstream waterways may be affected by the proposed activity or ongoing activities.
- Assess the survival of the EAD agent in water.
- Assess the presence and depth of aquifers in the area.
- Assess the likely future movement of the watertable.
- Assess the current and possible future use of groundwater under the site.
- Assess the permeability of the soils surrounding the operation.
- Assess options to prevent pollution of groundwater.

Transport

Assessment

- Assess the requirement for, and availability of, appropriately licensed waste transporters and other contractors.

Operational

- Ensure that drivers have been trained and licensed, and vehicles are licensed, to transport the appropriate class of dangerous goods.
- Ensure that appropriate biosecurity measures are in place.

Monitoring

Operational

- Check that a monitoring program appropriate for the site and surrounding environment is in place, with clear responsibility for its operation.
- Check who the monitoring data should be provided to and assessed by.
- Check the requirement for, and duration of, a monitoring program.
- Ensure that contingency procedures exist should the monitoring indicate a problem, and that it is clear who will be responsible for taking action.

Burning of carcasses

Assessment

- Check the direction and speed of the prevailing winds and other likely winds, and ensure that contingency plans are available if wind direction changes.
- Check that the current weather and weather forecast in the area are favourable for pit/pyre construction and burning. Ensure that fuels of appropriate quality and quantity are available.
- Ensure that plans are in place to minimise emissions and air pollution.
- Ensure that care has been taken in construction to ensure that runoff from the site does not cause pollution of waters or site contamination.
- Ensure that the smoke generated by the fire does not cause an aviation hazard or adversely affect the community.
- Ensure that the pyres as constructed will result in 100% kill of the EAD agent.

Operational

- Check that no fire ban or no-burn day is current, and that appropriate permits have been obtained.
- Check that arrangements have been made to dispose of ash and minimise the risk of leaching.
- Ensure that personnel constructing the pyre or pit have been trained in its construction to maximise the efficiency of the burn.
- Ensure that smoke from the fire is minimised and burning is efficient.
- Ensure that air-quality monitoring is planned.
- If pits are constructed, ensure that site remediation is planned.

Burial

Assessment

- Check whether the soil at depth is nonpermeable, and the integrity of the soil is such that it will retain leachate over time.
- Assess soil acidity.
- Check whether the bottom or sides of the pit show signs of fissures that might result in loss of containment.
- Assess the need for liners to be used, if the soils may not provide sufficient protection of groundwater.

- Plan whether leachate should be collected or processed, and the need for leachate to be treated.
- Assess whether gas generation from putrescible waste is likely to be a problem, and plan how the gases generated from the site will be released or processed.

Operational

- Obtain any necessary permits.
- Assess the availability and timeliness of supply of suitable liner and capping material, if required.
- Assess the requirement for capping material and the type to be used.
- Assess the monitoring regime to be implemented for the burial site, leachate system, gas system and groundwater.
- Assess likely subsidence of the pit with the total decomposition of the buried carcasses, and implement appropriate contingency plans to remediate this.
- Assess the need for medium-term mitigation of risks to the public.

Landfill

Assessment

- Assess the availability of suitable landfills within a practical distance.
- Assess the licence type and quality of management of the landfill site. Assess the need for extra biosecurity procedures and measures at the site, and training for site personnel.
- Check whether the use of the landfill is likely to cause short-, medium- or long-term problems for the local community because of diminished capacity as a result of its use in the EAD response.

Operational

- Check the monitoring procedures that are required.
- Develop a monitoring plan for biosecurity measures implemented.

Composting

Assessment

- Assess the availability of sufficient suitable land on the infected premises or within practical distance from the infected premises. Check whether an existing commercial operation can be used.
- Assess the need for management practices to protect the environment.
- Ensure that a suitable source of the carbon required for composting is available.

- Assess the need for extra biosecurity procedures and measures at the site, and training for site personnel.
- Assess the options for using or disposing of the final compost product (eg farms with or without livestock, forest land, gardens, disposal to landfill or other burial).

Operational

- Assess the availability of ongoing expertise to manage the process.
- Plan the implementation of best-practice management of the site.
- Ensure that measures to protect the site from predators and feral animals are in place.
- Assess the need for monitoring procedures for the site.

Appendix 4 Transport checklist

General

- What needs to be transported?
 - Liquids
 - Solids
 - Live animals (consider animal welfare issues)
 - Carcasses
 - Machinery
 - Fuel
 - Other _____
- How much is to be transported?
Approximate volume _____
- How far does it have to be transported?
Approximate distance _____
- What is the timeframe for transport?
- What biosecurity procedures need to be implemented?
- How will the vehicles be loaded and unloaded?
- Given the type and volume of materials to be transported, and the distance, are there readily available transport resources to meet the task?
- Is the disease transmissible to humans?
- Is there a ready supply of covers and liners for trucks? If not, what is the lead time for supply?
- What decontamination processes for drivers and vehicles need to be followed? (These will affect turnaround time and environmental protection.)
- Has a site for decontamination of vehicles been established?
- Will decontamination processes affect the vehicle? What protections need to be in place?
- What training is required? (See below, under 'Driver training'.)
- Are there adequate access and exit points for vehicles at pick-up, at destination and along the route to be followed?

- Is the ground suitable for heavy vehicles at all points, taking into account the stability of the ground and axle loadings on uneven ground?
- Is there a ready supply of tarps, etc for trucks? If not, what is the lead time for supply?
- For chilling, are the carcasses already frozen? (Refrigerated vehicles will keep frozen goods at -20 °C, but will not freeze them.)
- Is the option chosen realistic, given the available resources?
- Is there an approved road accident strategy?
- Has the emergency management transport coordinator been consulted in the decision-making process?
- Are all vehicles fit for purpose, and has a process been established to record vehicle defects? (This should be done **before** starting work.)
- Are legal requirements satisfied (eg classes of material to be transported, specification of routes, requirements for placards, times of travel, driver qualifications)?
- Has the appropriate authority been involved?
- Has the public been advised of routes and the safeguards in place?
- What are the likely costs, and have they been approved?

Driver training

- Has consideration been given to precautions the driver needs to take?
- Is there any long-term impact on the vehicle?
- What training is required for the drivers and owners of vehicles?
- Is a training information package available?
- What timeframe is required to deliver the training?
- Does the training/education material address all the concerns of the driver/owner?
- Are emergency decontamination kits available, and are drivers trained in their use?

Appendix 5 Form for reporting recommendations to LCC Controller on disposal options

Case no: _____

LCC _____ (location)

Property identifier/district _____

I recommend that the following disposal options be implemented at (description of properties or relevant area):

Prioritised list of recommended disposal options:

- 1.
- 2.
- 3.
- 4.

Rationale for this recommendation in summary (further information attached):

LCC Disposal Coordination

Name:..... Signature:..... Date:

Attachments

- Membership of expert team
- Decision-making process
- Summary of advantages and disadvantages for each recommendation
- Summary of reasons for rejection of unacceptable options
- List of reference material used

Approved

LCC Operations Management

Name:..... Signature:..... Date:

LCC Controller

Name:..... Signature:..... Date:

Appendix 6 Burial pit construction

Activities on burial sites have significant safety risks, and the safety of operational personnel is an overriding consideration. The engagement of an officer trained in work health and safety (WHS) is a critical component of risk management. Decisions on layout, design, equipment flow and other issues that affect the safety of the site should be made by the infected premises operations (IPOP)s team, in consultation with the contractors on the site, as well as facility management when commercial landfills are used. If the cause of the emergency is a disease that is a zoonosis (eg avian influenza or Hendra virus infection), additional WHS measures may need to be taken to prevent infection of burial site workers.

Other issues to consider include the hygiene of the personnel working on the site, the availability of rescue equipment if a person falls into the pit or if the pit wall collapses, and protection from noise and dust. All operations should be controlled by infected premises site supervisory (IPSS) personnel or commercial facility personnel. Personnel should be properly trained and briefed before operations begin. Biosecurity for the site remains the responsibility of infected premises security (IPS) personnel.

Earthmoving equipment

The preferred equipment for digging the burial pit will depend on the design of the pit. Excavators are the most efficient equipment for construction of long, deep, vertically sided pits, and allow the easy storage of topsoil separately from subsoil. If required, the equipment can also be used to fill the pit with carcasses or other materials, and to close it without disturbing the contents. Most excavators have an attachable hammer for rock work.

Loaders, bulldozers, road graders and backhoes (for small jobs) may be used if excavators are not available.

Excavators and backhoes remain in a fixed position while digging, and therefore move soil faster, with less cost and less damage to the site surrounding the pit. The other types of equipment move across the site during work.

Burial pit construction

The expert team should select the pit design. Construction of the pit and whether it needs to be lined will rely on advice from engineers and representatives from environment protection agencies.

Soils should be stable enough to withstand the weight of equipment used to construct and fill the pit. If necessary, surface runoff should be prevented from entering the pit by the construction of diversion banks. Similar banks should be constructed to prevent any liquids escaping from the burial site. Fencing may be necessary to exclude animals and people until the site is safe for use.

Straight-sided (trench) pit dimensions

The following guidelines may help in determining the pit volume required for straight-sided pits.

The base of the pit must be at the required level (at least 2 metres) above the watertable.

The volume required will depend on the size of the animals. As a guide, use the information below; then modify the volume using observed dimensions occupied by the first carcasses deposited in the pit:

- 1.5 m³ per mature cow.
- 0.3 m³ per mature pig or sheep.
- 0.005 m³ per grown broiler/commercial layer (200 birds/m³).
- Required depth of soil to cover carcasses: 2 m.

The number of cows or sheep that can be accommodated per linear metre of a pit 3 metres wide and 5 metres deep filled with carcasses to within 2 metres of ground level (see Figure A6.1) can be calculated as shown below.

First, calculate the volume of pit available for burial per linear metre of the pit (the effective volume):

$$\begin{aligned} \text{Effective volume} &= \text{width} \times \text{depth of carcasses} \times \text{length} \\ &= 3.0 \text{ m} \times 3.0 \text{ m} \times 1.0 \text{ m} \\ &= 9.0 \text{ m}^3 \end{aligned}$$

Then divide by the volume required per animal:

$$9.0/1.5 = 6 \text{ cattle}$$

$$9.0/0.3 = 30 \text{ sheep}$$

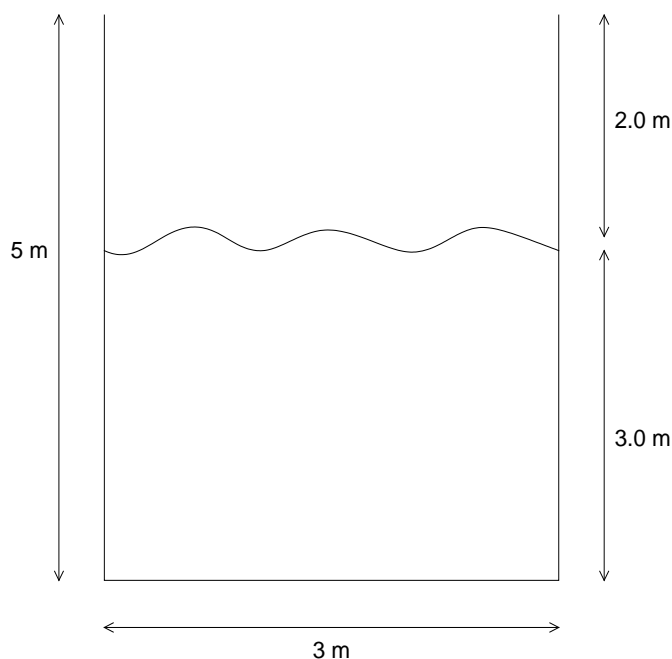

Figure A6.1 Example of the dimensions of a straight-sided pit

Battered pit dimensions

To overcome the WHS issues associated with straight-sided pits in some locations, such as collapsing walls, and environmental concerns about uncontained leachate, it may be necessary to use a pit with outwardly sloping (battered) sides to prevent collapse and allow for impervious liners to contain leachate. There must also be enough cover to prevent carcasses from surfacing.

Relevant information is as follows:

- 1.5 m³ per cow.
- 0.3 m³ per pig or sheep.
- Minimum depth of pit: 5 m.
- Required depth of soil to cover carcasses: 2 m.

The number of cows and sheep that can be accommodated per linear metre of a pit 3 metres wide at the base, 5 metres wide at the top of the carcasses, and 5 metres deep, filled with carcasses to within 2 metres of ground level (see Figure A6.2) can be calculated as follows.

Because the width changes from the top to the bottom of a battered pit, the average width must be used to calculate the volume of the pit. That is:

$$\text{Volume of a pit} = \text{mean width} \times \text{vertical height} \times \text{length}$$

Therefore, first calculate the mean width of the effective volume:

Width at base of pit: 3 m

Width at top of carcasses: 5 m

Mean width: 4 m

Then calculate the effective volume:

$$\begin{aligned} \text{Effective volume} &= \text{mean width (of effective volume)} \times (\text{vertical height of carcasses}) \times \\ &\text{length} \\ &= 4 \text{ m} \times (5 - 2) \text{ m} \times 1 \text{ m} \\ &= 12 \text{ m}^3 \end{aligned}$$

Then divide by the volume required per animal:

$$\text{eg } 12/1.5 = 8 \text{ cattle}$$

$$12/0.3 = 40 \text{ sheep}$$

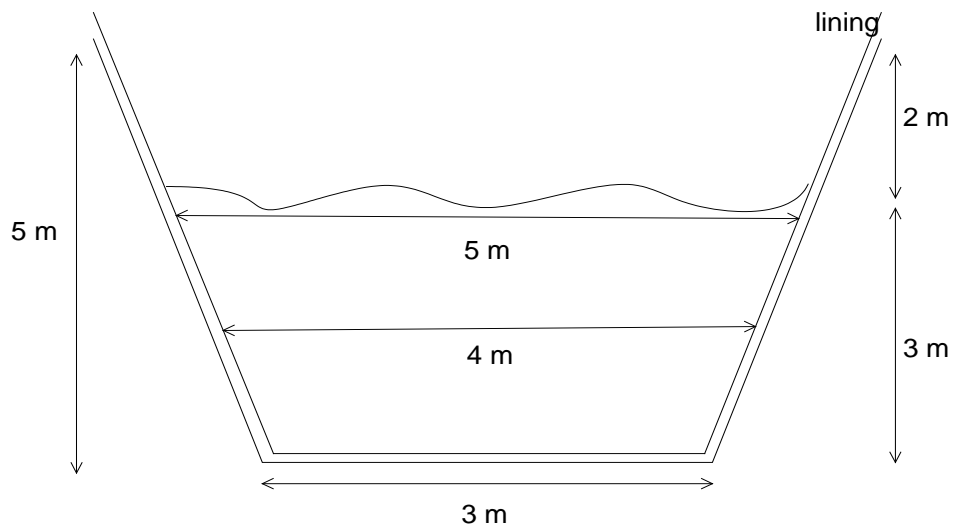

Figure A6.2 Example of the dimensions of a battered burial pit

Appendix 7 Pyre construction

When constructing a pyre, it is important to maximise the airflow from wind. Typically, pyres are rectangular in shape, with the long edge at 90 degrees to the direction of the prevailing wind. When timber is used as a solid fuel source, the bottom row should be parallel to the wind, with a gap between the lengths equivalent to the diameter of the timber pieces. The second layer should be placed at 90 degrees to the first layer, again with a gap between lengths. This cross-hatching should continue until the desired height is achieved. Larger-diameter timber should be used at the base of the pyre and smaller timber towards the top. Additional trenching underneath the pyre may improve airflow but is not necessary if the pyre is constructed in the above manner.

Other primary fuel sources (eg coal briquettes) can be used to supplement some of the timber; however, too large a quantity will reduce the overall airflow and produce more smoke. One layer in the middle of the pyre will be effective.

Straw or hay should only be used as a fire starter, not in the main body of the pyre. Bales should be opened and spread along the windward side of the pyre.

Experience has demonstrated that a single bovine carcass (around 500 kg) can be completely consumed using 1.5 tonne of dry timber (Worsfold and King 2006). For multiple carcasses, the amount of timber can be reduced to around 1.0 tonne per adult bovine. Carcasses are layered onto the pyre, preferably on their backs. Because the rear ends of bovine carcasses are usually the hardest to consume, alternating carcasses head to tail can even out the burn. Carcasses should only be stacked one row high and should have sufficient air space around them (Figure A7.1). The number of carcasses per pyre should be limited to a manageable level. Restricting airflow around the carcasses will reduce the efficiency of combustion and produce more smoke. Excavators are preferable for laying carcasses, but front-end loaders and chains can be used. There is no need to cut extensor tendons before burning.

Liquid fuels are required to start burning a pyre; the volume required depends on the size. For safety reasons, diesel is the preferred liquid fuel. When lighting, ignition points should be prepared at suitable intervals along the length of the pyre. These may consist of rags soaked in hydrocarbon (ie diesel). Alternatively, fuelgel⁶ can be used to initiate large pyres – it can provide a more sustained burn time and is not as volatile as liquid fuel.

The pyre should be monitored for unstable carcasses and adjusted only when safe to proceed. A well-constructed large pyre should consume carcasses within 24–48 hours. The remaining ashes should be disposed of by burial on-site.

⁶ Fuelgel is the product that results from mixing a liquid or solid gelling agent with a hydrocarbon.

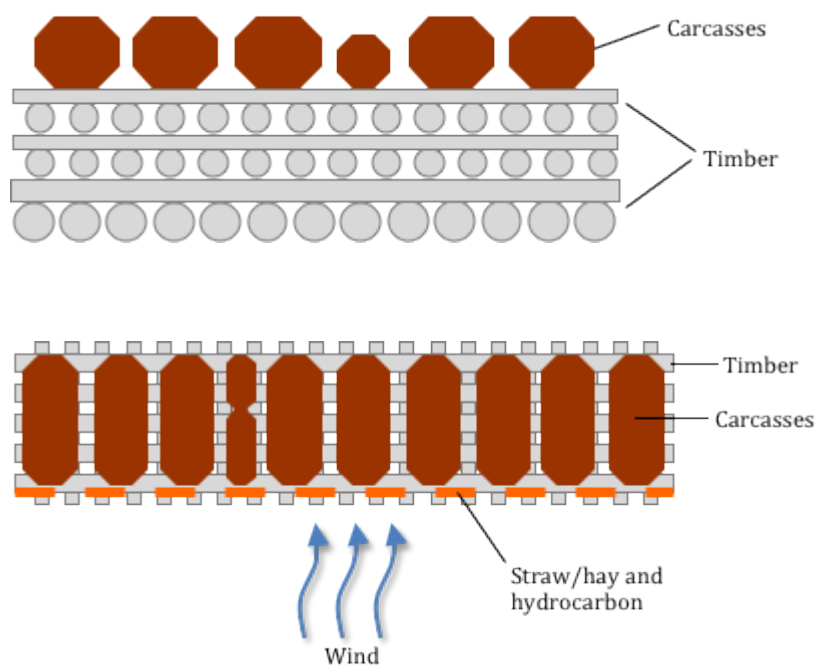

Figure A7.1 Example of construction of a pyre, including aerial view (lower diagram)

Appendix 8 Sample decision-making process for determining appropriate disposal options

Step 1

Determine which disposal methods can be effectively used to control and destroy the emergency animal disease (EAD) agent.

Step 2

Appendix 1 lists wastes generated during EAD outbreaks. Determine the type and quantity of waste likely to be generated and the waste-stream classification that each category of waste is likely to be in. If necessary, treat the waste to reduce its waste category to the lowest level (ie the easiest for disposal). Much of the waste generated will be in small quantities and, unless it is 'hazardous', should be able to be processed using existing waste treatment facilities. For example, clinical wastes and sharps could be disposed of via licensed clinical waste contractors.

Step 3

Assess the relative importance of the following factors for the disposal methods identified in steps 1 and 2 (additional factors may need to be included, as appropriate):

- operator safety
- community concerns
- international acceptance
- transport availability
- legislative requirements
- industry standards
- cost-effectiveness
- speed of resolution.

Use a decision-making matrix to compare each method with the others, taking all of the factors into account. The matrix can be set up in a spreadsheet, with the disposal methods listed in columns and the factors in rows (see Table A8.1). Using a spreadsheet will allow quick recalculation of weightings and values, and testing of various combinations. Different matrixes may be required for different materials (eg carcasses, litter, products), depending on the situation.

Table A8.1 Blank decision matrix

Factor	Weighting	Method							
		Pyre		Burial		Composting		Rendering	
		Utility	Value	Utility	Value	Utility	Value	Utility	Value
Operator safety									
Community concerns									
International acceptance									
Transport availability									
Legislative requirements									
Industry standards									
Cost-effectiveness									
Speed of resolution									
Total	100		Sum		Sum		Sum		Sum

Each factor is weighted by its relative importance (F). For example, operator safety and community concern will be weighted highly compared with other factors. The total of all weightings must be 100 (Table A8.2). For each disposal method being assessed, allocate two columns. The first column is a utility value (U). This value is a number between 1 and 10, allocated according to how well a disposal method achieves or attains the ideal (1 = the worst possible fit and 10 = the best fit). The second column is the value (V) of the factor's weighting (F) multiplied by the utility value ($V = F \times U$).⁷

Table A8.2 Example matrix with weightings

Factor	Weighting	Method							
		Pyre		Burial		Composting		Rendering	
		Utility	Value	Utility	Value	Utility	Value	Utility	Value
Operator safety	20								
Community concerns	15								
International acceptance	15								
Transport availability	15								
Legislative requirements	10								
Industry standards	10								
Cost-effectiveness	10								
Speed of resolution	5								
Total	100		Sum		Sum		Sum		Sum

The factor weightings and the utility values are estimates made at the location by people who know and understand local conditions. There are no hard-and-fast rules for the estimates, other than that they should be in proportion to each other based on knowledge of local conditions. Because any one person will be unlikely to have a full understanding of all the information required, it is suggested that the expert team (see Section 2.4) be consulted before this decision framework is used.

⁷ The figures used in the example in these tables are not meant to reflect a particular EAD or situation.

After a weighting is given to each factor and a utility value is allocated to each disposal method, values produced for each factor can be summed to give a total for each disposal method (Table A8.3). Once this is calculated for all methods, they can be compared with each other and ranked according to their sums. In this example, rendering is best, followed by burial and composting.

Table A8.3 Example of completed matrix

Factor	Weighting	Method							
		Pyre		Burial		Composting		Rendering	
		Utility	Value	Utility	Value	Utility	Value	Utility	Value
Operator safety	20	5	100	5	100	8	160	10	200
Community concerns	15	2	30	6	90	8	120	10	150
International acceptance	15	8	120	8	120	5	75	10	150
Transport availability	15	10	150	10	150	10	150	4	60
Legislative requirements	10	10	100	8	80	8	80	10	100
Industry standards	10	6	60	8	80	5	50	10	100
Cost-effectiveness	10	5	50	5	50	5	50	6	60
Speed of resolution	5	8	40	8	40	5	25	10	50
Total	100		650		710		710		870

Step 4

Assess the resources available to carry out the disposal methods identified in step 3. If resources are not available, delete the method. If resources are limited, plan to use the disposal method with the highest score first, before moving to the method with the next highest score. For example, rendering usually outscores most other disposal methods, but has either a limited capacity or none at all. If it is available, use it first.⁸

Step 5

Assess the environmental impacts of the remaining disposal methods and choose the method with the least impact on the environment.

⁸ See AS 5008:2007: Australian standard for the hygienic rendering of animal products (www.publish.csiro.au/pid/5666.htm).

Appendix 9 Overview of effluent systems

Terminology

Collectively, urine and dung are called excreta. Excreta is typically mixed with wash water produced by cleaning yards; with wash water, chemicals and residual milk from cleaning equipment; with waste feed or bedding material; and occasionally with rainwater. The resulting liquid is usually referred to as effluent (or dairy shed effluent or wastewater).

Excreta that dries before being collected (eg by scraping from feed pads or loafing yards) and is handled as a semisolid or solid is called manure. Manure can also contain waste feed or bedding material, and soil removed by scraping nonconcrete areas.

Effluent systems and principles

Once considered purely as a useless byproduct or waste, and a potential environmental pollutant, effluent is now considered a valuable nutrient and water resource if it is properly managed, and if environmental risks are identified and addressed.

Most agricultural activity involving farm animals will produce some level of effluent, which is managed during usual activities. Dairy farms and intensive operations (eg feedlots, pigs and poultry) produce the largest amounts of effluent.

There are two major types of effluent management systems: continuous application systems, and treatment and storage systems (effluent ponds).

Continuous application systems

Continuous application systems are not designed to treat effluent and have limited storage capacity. Consequently, they rely on regular collection and application of effluent, usually twice daily. The effluent is generally collected in a concrete sump and applied directly to pasture as raw (untreated) effluent.

The main types of continuous application systems are:

- sump and gravity flow (generally through a movable hose)
- sump, pump and movable sprinkler
- sump and effluent tanker.

To protect pumps and prevent pipe blockages, each of these systems needs a stone trap, screen or trafficable solids trap to remove coarse solids and foreign material from the effluent stream before it enters the sump.

Provision should be made to store the effluent during extended periods of wet weather when spray irrigation of effluent should not take place (to avoid pollution of rivers and creeks from the runoff). Application of effluent to pastures by a spray irrigator requires regular manual or automatic shifting of the irrigator to avoid excessive application, so that the soil is not overloaded and the pasture is palatable to cows at the next grazing.

Single or multiple effluent ponds

From an environmental perspective, effluent ponds are generally preferable to continuous application systems in drier areas.

On dairy farms, these systems employ one or more ponds (generally one or two) to treat the daily inflow of effluent from the milking shed and yards, and to store both the liquid effluent and solids (sludge) that settle out of the effluent. Pond systems can also collect, treat and store runoff from concrete and earth yards, and, in some cases, feed pads and regularly used laneways. The liquid effluent is stored until it is either irrigated onto crop or pasture, or recycled for yard flushing purposes.

A number of ponds may be constructed in series to treat and store effluent. The first pond in such a series is generally referred to as the primary pond and the second pond as the secondary pond. The quality of the treated effluent in the final pond generally improves as the number of ponds in the effluent management system increases.

Sludge accumulates in the primary pond and is removed at regular intervals. Primary ponds are commonly designed to store 1–10 years of accumulated sludge. The sludge storage capacity generally depends on the intended method of sludge removal. For example, if a farmer wishes to employ a contractor with an excavator to remove the sludge, they may prefer to limit desludging operations to a frequency of once every 10 years. Alternatively, if the farmer has ready access to a vacuum tanker, they may choose to pump out and apply the sludge as a fertiliser much more frequently, perhaps annually.

Regardless of the number of ponds in the effluent management system, the following three storage/treatment volume components must be provided:

- active treatment volume to maintain the necessary bacterial population to treat and break down the organic matter in the effluent stream
- sludge storage volume to store the solids that settle out of the effluent during treatment
- wet weather storage volume to store liquid effluent during periods when the land is too wet for effluent irrigation, or until the timing of effluent irrigation suits other farm management considerations.

In a single-pond system, each of these three treatment/storage volumes must be provided in the primary pond (see Figure A9.1). In a double-pond system, the active treatment volume and sludge storage volume must be provided in the primary pond, and the wet weather storage volume in the secondary pond (see Figure A9.2).

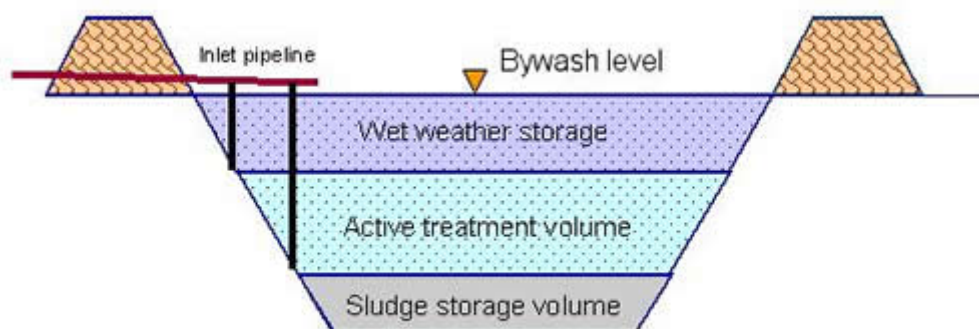

Figure A9.1 Cross-section of single effluent pond, showing treatment volumes

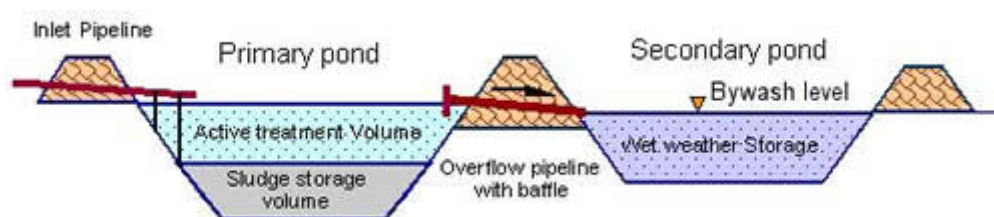

Figure A9.2 Cross-section of double effluent pond, showing location of storage volumes in each pond

Effluent ponds should have sufficient wet weather storage capacity to limit effluent spills (overtopping) to a frequency not exceeding once every 10 years, except in sensitive environmental areas, where less frequent overtopping may be desirable. Effluent ponds should not generally be located close to watercourses. However, if this is unavoidable, additional wet weather storage capacity may be required to further limit effluent spills.

The 'treatment' of the effluent consists of allowing solids to settle to the bottom of the pond as sludge. Both sludge and liquids become a medium for the growth of bacteria that occur normally in faecal matter or the environment. These bacteria may be aerobic, anaerobic or both (facultative). The bacteria and phytoplankton break down the remaining organic compounds in the effluent and produce either methane and carbon dioxide (anaerobic) or water and carbon dioxide (aerobic) as byproducts. The remaining effluent contains simpler organic nutrients and minerals that are more suitable for applying to pasture.

Glossary

Aerosol	Particles suspended in the air.
Air curtain incineration	Incineration method in which air is forced through a manifold, creating a turbulent environment that accelerates incineration.
Agriculture Ministers' Forum	The council of Australian national, state and territory, and New Zealand ministers of agriculture that sets Australian and New Zealand agricultural policy (formerly the Standing Council on Primary Industries). <i>See also</i> Animal Health Committee
Animal byproducts	Products of animal origin that are not for consumption but are destined for industrial use (eg hides and skins, fur, wool, hair, feathers, hooves, bones, fertiliser).
Animal Health Committee	A committee whose members are the Australian and state and territory CVOs, the Director of the CSIRO Australian Animal Health Laboratory (CSIRO-AAHL), and the Director of Environmental Biosecurity in the Australian Government Department of the Environment. The committee provides advice to the Agriculture Ministers' Forum on animal health matters, focusing on technical issues and regulatory policy (formerly called the Veterinary Committee). <i>See also</i> Agriculture Ministers' Forum
Animal products	Meat, meat products and other products of animal origin (eg eggs, milk) for human consumption or for use in animal feedstuff.
Australian Chief Veterinary Officer	The nominated senior veterinarian in the Australian Government Department of Agriculture who manages international animal health commitments and the Australian Government's response to an animal disease outbreak. <i>See also</i> Chief veterinary officer
AUSVETPLAN	<i>Australian Veterinary Emergency Plan.</i> A series of technical response plans that describe the proposed Australian approach to an emergency animal disease incident. The documents provide guidance based on sound analysis, linking policy, strategies, implementation, coordination and emergency-management plans.
Chief veterinary officer (CVO)	The senior veterinarian of the animal health authority in each jurisdiction (national, state or territory) who has responsibility for animal disease control in that jurisdiction. <i>See also</i> Australian Chief Veterinary Officer

Compensation	The sum of money paid by government to an owner for livestock or property that are destroyed for the purpose of eradication or prevention of the spread of an emergency animal disease, and livestock that have died of the emergency animal disease. <i>See also</i> Cost-sharing arrangements; Emergency Animal Disease Response Agreement
Consultative Committee on Emergency Animal Diseases (CCEAD)	The key technical coordinating body for animal health emergencies. Members are state and territory CVOs, representatives of CSIRO-AAHL and the relevant industries, and the Australian CVO as chair.
Control area	A legally declared area where the disease controls, including surveillance and movement controls, applied are of lesser intensity than those in a restricted area (the limits of a control area and the conditions applying to it can be varied during an incident according to need).
Cost-sharing arrangements	Arrangements agreed between governments (national and states/territories) and livestock industries for sharing the costs of emergency animal disease responses. <i>See also</i> Compensation, Emergency Animal Disease Response Agreement.
Dangerous contact animal	A susceptible animal that has been designated as being exposed to other infected animals or potentially infectious products following tracing and epidemiological investigation.
Dangerous contact premises	A premises, apart from an abattoir, knackery or milk processing plant (or other such facility) that, after investigation and based on a risk assessment, is considered to contain a susceptible animal(s) not showing clinical signs, but considered highly likely to contain an infected animal(s) and/or contaminated animal products, wastes or things that present an unacceptable risk to the response if the risk is not addressed, and that therefore requires action to address the risk.
Declared area	A defined tract of land that is subjected to disease control restrictions under emergency animal disease legislation. There are two types of declared areas: restricted area and control area.
Decontamination	Includes all stages of cleaning and disinfection.
Depopulation	The removal of a host population from a particular area to control or prevent the spread of disease.
Destroy (animals)	To kill animals humanely.
Disease agent	A general term for a transmissible organism or other factor that causes an infectious disease.

Disease Watch Hotline	24-hour freecall service for reporting suspected incidences of exotic diseases – 1800 675 888
Disinfectant	A chemical used to destroy disease agents outside a living animal.
Disinfection	The application, after thorough cleansing, of procedures intended to destroy the infectious or parasitic agents of animal diseases, including zoonoses; applies to premises, vehicles and different objects that may have been directly or indirectly contaminated.
Disinfestation	The removal of insects from animals.
Disinsectisation	The application of procedures intended to eliminate arthropods that may cause disease or are potential vectors of infectious agents of animal diseases.
Disposal	Sanitary removal of animal carcasses, animal products, materials and wastes by burial, burning or some other process so as to prevent the spread of disease.
Emergency animal disease	A disease that is (a) exotic to Australia or (b) a variant of an endemic disease or (c) a serious infectious disease of unknown or uncertain cause or (d) a severe outbreak of a known endemic disease, and that is considered to be of national significance with serious social or trade implications. <i>See also</i> Endemic animal disease, Exotic animal disease
Emergency Animal Disease Response Agreement	Agreement between the Australian and state/territory governments and livestock industries on the management of emergency animal disease responses. Provisions include participatory decision making, risk management, cost sharing, the use of appropriately trained personnel and existing standards such as AUSVETPLAN. <i>See also</i> Compensation; Cost-sharing arrangements
Endemic animal disease	A disease affecting animals (which may include humans) that is known to occur in Australia. <i>See also</i> Emergency animal disease, Exotic animal disease
Enterprise	<i>See</i> Risk enterprise
Epidemiological investigation	An investigation to identify and qualify the risk factors associated with the disease. <i>See also</i> Veterinary investigation
Exotic animal disease	A disease affecting animals (which may include humans) that does not normally occur in Australia. <i>See also</i> Emergency animal disease, Endemic animal disease
Exotic fauna/feral animals	<i>See</i> Wild animals

Fomites	Inanimate objects (eg boots, clothing, equipment, instruments, vehicles, crates, packaging) that can carry an infectious disease agent and may spread the disease through mechanical transmission.
Groundwater	Any water contained in an aquifer.
In-contact animals	Animals that have had close contact with infected animals, such as noninfected animals in the same group as infected animals.
Incubation period	The period that elapses between the introduction of the pathogen into the animal and the first clinical signs of the disease.
Index case	The first case of the disease to be diagnosed in a disease outbreak. <i>See also</i> Index property
Index property	The property on which the index case is found. <i>See also</i> Index case
Infected premises	A defined area (which may be all or part of a property) on which animals meeting the case definition are or were present, or the causative agent of the emergency animal disease exists, or there is a reasonable suspicion that either exists, and that the relevant chief veterinary officer or their delegate has declared to be an infected premises.
Landfill site	A licensed site for the disposal of approved wastes to land.
Leachate	Liquid impurities resulting from decomposition, with the potential to percolate through soil.
Local control centre (LCC)	An emergency operations centre responsible for the command and control of field operations in a defined area.
Monitoring	Routine collection of data for assessing the health status of a population, or the level of contamination of a site for remediation purposes. <i>See also</i> Surveillance
Movement control	Restrictions placed on the movement of animals, people and other things to prevent the spread of disease.
National management group (NMG)	A group established to approve (or not approve) the invoking of cost sharing under the Emergency Animal Disease Response Agreement. NMG members are the Secretary of the Australian Government Department of Agriculture as chair, the chief executive officers of the state and territory government parties, and the president (or analogous officer) of each of the relevant industry parties.
Native wildlife	<i>See</i> Wild animals

OIE Terrestrial Code	OIE <i>Terrestrial animal health code</i> . Describes standards for safe international trade in animals and animal products. Revised annually and published on the internet at: www.oie.int/international-standard-setting/terrestrial-code/access-online .
OIE Terrestrial Manual	OIE <i>Manual of diagnostic tests and vaccines for terrestrial animals</i> . Describes standards for laboratory diagnostic tests and the production and control of biological products (principally vaccines). The current edition is published on the internet at: www.oie.int/international-standard-setting/terrestrial-manual/access-online .
Open burning	The burning of wastes in the open without any control over emissions.
Operational procedures	Detailed instructions for carrying out specific disease control activities, such as disposal, destruction, decontamination and valuation.
Outside area	The area of Australia outside the declared (control and restricted) areas.
Owner	Person responsible for a premises (includes an agent of the owner, such as a manager or other controlling officer).
Premises	A tract of land including its buildings, or a separate farm or facility that is maintained by a single set of services and personnel.
Prevalence	The proportion (or percentage) of animals in a particular population affected by a particular disease (or infection or positive antibody titre) at a given point in time.
Putrescible waste	Waste able to be decomposed by the action of microorganisms.
Quarantine	Legal restrictions imposed on a place or a tract of land by the serving of a notice limiting access or egress of specified animals, persons or things.
Remediation	The remedying of a site to reverse or stop damage to the environment.
Rendering	Processing by heat to inactivate infective agents. Rendered material may be used in various products according to particular disease circumstances.
Restricted area	A relatively small legally declared area around infected premises and dangerous contact premises that is subject to disease controls, including intense surveillance and movement controls.

Risk enterprise	A defined livestock or related enterprise that is potentially a major source of infection for many other premises. Includes intensive piggeries, feedlots, abattoirs, knackeries, saleyards, calf scales, milk factories, tanneries, skin sheds, game meat establishments, cold stores, artificial insemination centres, veterinary laboratories and hospitals, road and rail freight depots, showgrounds, field days, weighbridges, garbage depots.
Sensitivity	The proportion of truly positive units that are correctly identified as positive by a test. <i>See also</i> Specificity
Sentinel animal	Animal of known health status that is monitored to detect the presence of a specific disease agent.
Serotype	A subgroup of microorganisms identified by the antigens carried (as determined by a serology test).
Specificity	The proportion of truly negative units that are correctly identified as negative by a test. <i>See also</i> Sensitivity
Stamping out	The strategy of eliminating infection from premises through the destruction of animals in accordance with the particular AUSVETPLAN manual, and in a manner that permits appropriate disposal of carcasses and decontamination of the site.
State coordination centre (SCC)	The emergency operations centre that directs the disease control operations to be undertaken in that state or territory.
Surveillance	A systematic program of investigation designed to establish the presence, extent or absence of a disease, or of infection or contamination with the causative organism. It includes the examination of animals for clinical signs, antibodies or the causative organism.
Susceptible animals	Animals that can be infected with a particular disease.
Suspect animal	An animal that may have been exposed to an emergency disease such that its quarantine and intensive surveillance, but not pre-emptive slaughter, is warranted. <i>or</i> An animal not known to have been exposed to a disease agent but showing clinical signs requiring differential diagnosis.
Suspect premises	Temporary classification of a premises that contains a susceptible animal(s) not known to have been exposed to the disease agent but showing clinical signs similar to the case definition, and that therefore requires investigation(s).

Swill	<p>Also known as 'prohibited pig feed', material of mammalian origin, or any substance that has come in contact with this material; it does not include:</p> <ul style="list-style-type: none"> • milk, milk products or milk byproducts, either of Australian provenance or legally imported for stockfeed use into Australia • material containing flesh, bones, blood, offal or mammal carcasses that is treated by an approved process • a carcass or part of a domestic pig, born and raised on the property on which the pig or pigs that are administered the part are held, that is administered for therapeutic purposes in accordance with the written instructions of a veterinary practitioner • material used under an individual and defined-period permit issued by a jurisdiction for the purposes of research or baiting.
Swill feeding	<p>Also known as 'feeding prohibited pig feed', includes:</p> <ul style="list-style-type: none"> • feeding, or allowing or directing another person to feed, prohibited pig feed to a pig • allowing a pig to have access to prohibited pig feed • the collection and storage or possession of prohibited pig feed on a premises where one or more pigs are kept • supplying to another person prohibited pig feed that the supplier knows is for feeding to any pig.
Tracing	<p>The process of locating animals, persons or other items that may be implicated in the spread of disease, so that appropriate action can be taken.</p>
Vaccination	<p>Inoculation of individuals with a vaccine to provide active immunity.</p>
Vaccine	<p>A substance used to stimulate immunity against one or several disease-causing agents to provide protection or to reduce the effects of the disease. A vaccine is prepared from the causative agent of a disease, its products or a synthetic substitute, which is treated to act as an antigen without inducing the disease.</p>
Vector	<p>A living organism (frequently an arthropod) that transmits an infectious agent from one host to another. A <i>biological</i> vector is one in which the infectious agent must develop or multiply before becoming infective to a recipient host. A <i>mechanical</i> vector is one that transmits an infectious agent from one host to another but is not essential to the life cycle of the agent.</p>
Veterinary investigation	<p>An investigation of the diagnosis, pathology and epidemiology of the disease. <i>See also</i> Epidemiological investigation</p>

Wild animals

- native wildlife Animals that are indigenous to Australia and may be susceptible to emergency animal diseases (eg bats, dingoes, marsupials).
- feral animals Animals of domestic species that are not confined or under control (eg cats, horses, pigs).
- exotic fauna Nondomestic animal species that are not indigenous to Australia (eg foxes).

Zoning

The process of defining, implementing and maintaining a disease-free or infected area in accordance with OIE guidelines, based on geopolitical and/or physical boundaries and surveillance, in order to facilitate disease control and/or trade.

Zoonosis

A disease of animals that can be transmitted to humans.

Abbreviations

AUSVETPLAN	Australian Veterinary Emergency Plan
BSE	bovine spongiform encephalopathy
EAD	emergency animal disease
FMD	foot-and-mouth disease
IP	infected premises
IPOPs	infected premises operations
IPS	infected premises security
IPSS	infected premises site supervisory
LCC	local control centre
TSE	transmissible spongiform encephalopathy
WHS	work health and safety

References

- ARA (Australian Renderers Association Inc) (2011). *2011 ARA Code of practice for hygienic rendering of animal products*. ARA, Baulkham Hills, New South Wales.
- ARA (Australian Renderers Association Inc) (2012). *2011 rendering facts*. ARA, Baulkham Hills, New South Wales.
- Auvermann B, Kalbasi A and Ahmed A (2004). Rendering. In: *Carcass disposal: a comprehensive review*, National Agricultural Biosecurity Center, Kansas State University, Chapter 4, 8-13.
- Bourne D (2001). *Burning of carcasses for foot-and-mouth disease (Disease investigation and control – treatment and care)*. Foot-and-Mouth Disease – Special Edition, WILDPro^(R) v3.0, CD.
- CFSPH and USDA (Center for Food Security and Public Health, and United States Department of Agriculture) (2012). *NAHEMS guidelines: disposal*. www.aphis.usda.gov/animal_health/emergency_management/downloads/nahems_guidelines/disposal_nahems.pdf
- Cumbria Foot and Mouth Disease Inquiry Panel (2002). *Cumbria foot and mouth disease inquiry report*, 76. www.cumbria.gov.uk/eLibrary/Content/Internet/538/716/37826163827.pdf
- De Klerk PF (2002). Carcass disposal: lessons from the Netherlands after the foot and mouth outbreak of 2001. *OIE Scientific and Technical Review* 21(3):789–796.
- Ford G (2003). Disposal technology seminar on air-curtain incineration. Midwest Regional Carcass Disposal Conference, Kansas City.
- Gloster J, Hewson H, Mackay D, Garland T, Donaldson A, Mason I and Brown R (2001). Spread of foot-and-mouth disease from the burning of animal carcasses on open pyres. Special article. *Veterinary Record*, 12 May 2001, 585–586.
- Guan J, Chan M, Grenier C, Wilkie DC, Brooks BW and Spencer JL (2009). Survival of avian influenza and Newcastle disease viruses in compost and at ambient temperatures based on virus isolation and real-time reverse transcriptase PCR. *Avian Diseases* 53:26–33.
- Himsworth CG (2008). The danger of lime use in agricultural anthrax disinfection procedures: the potential role of calcium in the preservation of anthrax spores. Special report. *Canadian Veterinary Journal* 49:12081210.
- Keener HM, Elwell DL and Monnin MJ (2000). Procedures and equations for sizing of structures and windrows for composting animal mortalities. *Applied Engineering in Agriculture* 16(6):681–692.
- Lu H, Castro AE, Pennick K, Liu J, Yang Q, Dunn P, Weinstock D and Henzler D (2003). Survival of avian influenza virus H7N2 in SPF chickens and their environments. *Avian Diseases* 47:1015–1021.

- NABC (National Agricultural Biosecurity Center) (2004). *Carcass disposal: a comprehensive review*, report prepared by the National Agricultural Biosecurity Center Consortium Carcass Disposal Working Group for the United States Department of Agriculture Animal and Plant Health Inspection Service, NABC, Kansas State University.
- Pluimers FH, de Leeuw PW, Smak JA, Elbers ARW and Stegeman JA (1999). Classical swine fever in the Netherlands 1997–1998: a description of organisation and measures to eradicate the disease. *Preventive Veterinary Medicine* 42(3–4):139–155.
- Scudamore JM, Trevelyan GM, Tas MV, Varley EM and Hickman GAW (2002). Carcass disposal: lessons from Great Britain following the foot and mouth disease outbreaks of 2001. *OIE Scientific and Technical Review* 21(3):775–787.
- SSC (Scientific Steering Committee) (2003). *Opinion on open burning of potentially TSE-infected animal materials*, Scientific Steering Committee, Health & Consumer Protection Directorate-General, European Commission.
http://ec.europa.eu/food/fs/sc/ssc/out310_en.pdf
- UK Environment Agency (2001). *The environmental impact of the foot and mouth disease outbreak: an interim assessment*, The Stationary Office, London.
- Wilkinson K (2006). *Mortality composting: a review of the use of composting for the disposal of dead animals*, report to the Victorian Department of Primary Industries.
- Wilkinson K, Davey M, Engleitner S, Warner S, Motha J and Hawes M (2014). *The biosecurity of mass poultry mortality composting*, RIRDC publication 13/098, RIRDC project PRJ-002325, Rural Industries Research and Development Corporation, Canberra.
- Williams S (2003). *Persistence of disease agents in carcasses and animal products*, report to Animal Health Australia. www.animalhealthaustralia.com.au/programs/emergency-animal-disease-preparedness/ausvetplan/resource-documents
- Worsfold D and King L (2006). *Evaluating the use of coal briquettes and fuel gel for open burning of bovine carcasses*, report to the Victorian Department of Environment and Primary Industries.

Further reading

- Agriculture and Resource Management Council of Australia and New Zealand, and Australian and New Zealand Environment and Conservation Council (1999). *National Water Quality Management Strategy: effluent management guidelines for intensive piggeries in Australia*. www.environment.gov.au/resource/effluent-management-guidelines-intensive-piggeries
- Williamson G (2010). *Destroy and Let Lie project report*, Biosecurity Queensland, Queensland Department of Employment, Economic Development and Innovation. www.agriculture.gov.au/biosecurity/emergency/wedpp/destroy_and_let_lie_disposal_project
- Effluent and manure management database for the Australian dairy industry: www.dairyingfortomorrow.com/index.php?id=48

Dairy effluent as a fertiliser – guidelines:

www.farmpoint.tas.gov.au/farmpoint.nsf/Biosecurity/8732DC36437B9EECCA2574A9001CB53E

Dairy effluent management systems: www.daff.qld.gov.au/animal-industries/dairy/environmental-management/effluent-management-systems